



Roofing System

Submittal Package

Project Name:

Project Address:

Roofing Contractor:



TPO-C Membrane (Standard, FR & Clean Film)

Polyester Reinforced, Heat-Weldable Membrane

PRODUCT DATA SHEET



DESCRIPTION

MuleHide TPO-C Membrane is a polyester reinforced, .045 or .060 thick, polyolefin-based, thermoplastic, heat-weldable membrane. High breaking strength, tearing strength, and puncture resistance is achieved by encapsulating a strong polyester fabric between the top and bottom plies. MuleHide TPO-C FR membrane is formulated with additional flame retardant (compared to Standard) for higher slope fire code approvals. The TPO-C membrane is also available in a 0.80" thickness (see Product Data Sheet for TPO-C EXTRA). The membrane is environmentally friendly and safe to install.

BASIC USES

The TPO-C membrane is used in mechanically attached, induction welded, and fully adhered roofing systems in new construction, reroofing and recover (retrofit) applications. It may also be used as flexible membrane flashings for walls, curbs, etc., when installing TPO-C membrane roofing systems. The system must be installed over acceptable roof insulation or other suitable substrates. See the MuleHide TPO Specifications Manual for complete specifications and details. MuleHide's 16' wide sheet is only available for fully adhered and induction welded roofs. The maximum sheet width that may be used for mechanically attached roof systems is 12' wide TPO membranes.

OPTIONAL CLEAN FILM

The TPO-C membrane is available with an optional CLEAN Film (Standard colors only), a temporary protective film factory-applied to the top surface of the membrane. By protecting the membrane surface from scuffs and dirt accumulation during installation, this protective film can save labor and time by helping to eliminate the need for roof cleaning upon project completion. CLEAN Film can be left in place for up to 90 days. Durable and easy to remove, CLEAN Film helps to improve the aesthetics and

long-term reflectivity and is ideal for use on re-roofing, re-cover and new construction projects. CLEAN Film is available on TPO-C 60-mil membranes supplied in 6' x100' and 10' x 100' rolls.

BENEFITS AND SUPPLEMENTAL STATEMENTS

- Wide window of weldability
- Outstanding puncture resistance
- Chlorine-free with no halogenated flame retardants
- UL 2218 Class 4 hail rating available on select systems
- Excellent low-temperature impact resistance
- Excellent chemical resistance to acids, bases, restaurant oils and greases
- Plasticizer-free, does not contain liquid or polymeric plasticizer
- Exceptional resistance to solar UV, ozone and oxidation
- Low water vapor permeance and water absorption
- Hot melt extrusion processed for complete scrim encapsulation
- Non-woven reinforcement fabric for smooth surface and greater thickness-over-scrim
- Polyester reinforcing fabric which is resistant to degradation by bacteria, mildew and fungi
- TPO-C is 100% recyclable
- Meets and exceeds requirements of ASTM D6878 Standard Specification for Thermal Plastic Polyolefin Based Sheet Roofing
- CLEAN Film guards the TPO membrane surface from scuffs and dirt accumulation during installation, helping to improve the roof systems appearance and maintain long-term reflectivity.
- CLEAN Film can be left in place for up to 90 days due to its excellent heat and UV resistance.
- MuleHide's tan and white TPO membranes are CRRC listed and California Title 24 compliant and can contribute toward LEED® (Leadership in Energy and Environmental Design) credits.

SPECIFICATIONS

Standard colors: White, Gray and Tan

Colorway colors: Medium Bronze, Patina Green, Rock Brown, Slate Gray and Terra Cotta

Materials: .045" (standard colors only) and .060" (nominal) thick polyester reinforced thermoplastic

Sizes: Standard colors: 4', 6', 8', 10', 12' and 16' sheet widths by 100' length
Colorway colors: 5' and 10' sheet widths by 100' length



TPO-C Membrane (Standard, FR & Clean Film)

Polyester Reinforced, Heat-Weldable Membrane

INSTALLATION INSTRUCTIONS

1. Approved insulation shall be attached to the roof deck with an approved insulation adhesive or approved fasteners and plates. Install insulation with its largest dimension perpendicular to the direction of the membrane seams where possible.
2. Mechanically Attached Roofing System
 - a. Perimeter sheets to be installed in an approved pattern along all exterior roof edges.
 - b. Mechanical fasteners and plates are installed in the seams of both the perimeter sheets and field sheets and into the roof deck. Use approved fasteners and maintain proper penetration for specific roof decks.
 - c. 12' wide sheet is the maximum sheet width for mechanically attached systems.
3. Fully Adhered Roofing System
 - a. Perimeter sheets are not required.
 - b. The membrane is required to be mechanically attached at the base of all vertical surfaces, roof edges, and angle changes.
 - c. The field of the roof is fully adhered to the substrate with a MuleHide approved adhesive.
4. Induction-Welded Roofing System
 - a. Membrane is attached over a suitable substrate utilizing an induction welding tool being placed over the membrane where a fastened TPO induction welding plate is located to weld the two components together.
5. Remove CLEAN Film from areas that are to be heat-welded together. In areas not requiring heat-welding, CLEAN Film can be left in place for up to 90 days. Upon completion of the TPO roofing system, remove the CLEAN film and discard.
6. All seams are hot-air welded and checked by probing.
7. All details will be done in accordance with MuleHide details.
8. On projects where a MuleHide System Warranty is requested, an authorized MuleHide representative shall inspect all completed work. This is only a brief summary and not the complete specification. MuleHide's specifications, details, technical bulletins, and associated documents should be thoroughly reviewed prior to starting any project. Contact the MuleHide Technical Department for additional information.

PRECAUTIONS

- Maximum sustained temperature not to exceed 160°F (71°C) for TPO membrane.
- Use proper stacking procedures to ensure roll stability. Avoid creasing the membrane.
- Surfaces may be slippery when wet, or due to frost and ice build-up. Exercise caution to prevent falls.

PRODUCT DATA SHEET

- MuleHide TPO membranes are highly reflective to sunlight. Workers should dress appropriately, wear sunscreen, and wear sunglasses that filter out UV light.
- Exercise care when working near roof edge as edges may not be visible when surrounding area is covered with snow.
- Store MuleHide membrane in original wrappings in a cool, shaded area. Cover with light-colored, breathable, waterproof tarpaulins. MuleHide membrane that has been exposed to the weather must be prepared with Weathered Membrane Cleaner prior to hot-air welding.
- Use proper stacking procedures to ensure sufficient stability of the rolls.
- Take care not to stand or place heavy objects on the edge of folded-over membrane, as this could cause a hard crease in the membrane.
- Do not use razor blades or other sharp tools to cut the CLEAN Film while it is still adhered to the TPO membrane as damage to the underlying membrane may occur. Pull the protective film away from the membrane prior to cutting.
- Remove CLEAN Film by pulling towards the center of the roof. Do not remove the film by pulling towards the roof edge.
- A static electricity charge may develop when removing the CLEAN Film from the surface of the membrane sheet. To avoid the possibility of ignition, lids must be closed on any flammable products and fire extinguishers should be readily available.
- Color membranes will 'fade' over time mainly due to the ultraviolet portion of sunlight. Since most roof surfaces are exposed to variable sunlight, some areas will be more susceptible to color changes caused by UV fading. Warranties for color membranes do not cover fading of colors.

EXTREME TESTING FOR SEVERE CLIMATES

ASTM Standard D6878 is the material specification for Thermoplastic Polyolefin-Based Sheet Roofing. It covers material property requirements for TPO roof sheeting and includes initial and aged properties after heat and xenon-arc exposure. As stated in the standard, "the tests and property limits used to characterize the sheet are values intended to ensure minimum quality for the intended purpose." MuleHide's goal is to provide TPO that delivers maximum performance for the intended purpose of roofing membranes. Maximum performance requires the membrane to far exceed the requirements of ASTM Standard D6878.



TPO-C Membrane (Standard, FR & Clean Film)

Polyester Reinforced, Heat-Weldable Membrane

PRODUCT DATA SHEET

Heat Aging accelerates the oxidation rate that roughly doubles for each 18°F (10°C) increase in roof membrane temperature. Oxidation (reaction with oxygen) is one of the primary chemical degradation mechanisms of roofing materials.

HEAT AGING		
Test Method	ASTM Requirement	Typical Results
ASTM Test - 240°F (116°C) No visible cracks	32 Weeks**	>128 Weeks
**Heat exposure comparable to 3,120 weeks (80 years) at 185°F for 8 hours per day.		
Test specimen is 2" by 6" piece of 45-mil membrane un-backed, placed in circulating hot-air oven. Criterion-no visible cracks after bending aged test sample around 3" diameter mandrel.		
Heat Aging accelerates the oxidation rate that roughly doubles for each 10° C (18° F) increase in roof membrane temperature. Oxidation (reaction with oxygen) is one of the primary chemical degradation mechanisms of roofing materials.		

Q-Trac testing combines accelerated weathering with real-world conditions using an array of ten mirrors to reflect and concentrate full spectrum sunlight onto membrane test specimens. The Q-Trac device automatically tracks the sun's path from morning to night. Also, it adjusts to compensate for seasonal changes in the sun's altitude. Eight years in Q-Trac testing is equal to 40 years of real-world exposure. MuleHide requires its TPO membranes to pass the equivalent of 40 years exposure in the Q-Trac.

Q-TRAC TESTING		
Test Method	ASTM Requirement	MH Requirement
ASTM Test N/A	NA	Equivalent of 40 years exposure
Environmental Cycling subjects the membrane to repeated cycles of heat aging, hot-water immersion and xenon-arc exposure.		
Test specimen is 2.75" by 5.5" piece of membrane with edges sealed. - 10 days heat aging at 240°F (116°C) followed by - 5 days water immersion at 158°F (70°C) followed by - 5,040 kJ/m ² (2000 hours at 0.70 W/m ² irradiance) xenon-arc exposure		
Criterion - after 3 completed cycles, test specimens shall remain flexible and not have any cracking under 10x magnifications while wrapped around a 3" diameter mandrel.		

SUPPLEMENTAL APPROVALS, STATEMENTS AND CHARACTERISTICS

- TPO-C meets and exceeds the requirements of ASTM D6878 Standard Specification for Thermoplastic Polyolefin Based Sheet Roofing.
- Radiative Properties for Cool Roof Rating Council (CRRC) and LEED.
- CRRC Product ID: TPO-C White 0670-0009.
- MuleHide TPO-C membranes conform to requirements of the U.S.E.P.A. Toxic Leachate Test (40 CFR part 136) performed by an independent analytical laboratory.
- TPO-C was tested for dynamic puncture resistance per ASTM D5635-04 using the most recently modified impact head. 45-mil was watertight after an impact energy of 12.5 J (9.2 ft-lbf) and 60-mil was watertight after an impact energy of 22.5 J (16.6 ft-lbf).
- NSF-P151 Certification for rainwater catchment systems components (Tooele Plant/White Only).

RADIATIVE PROPERTIES FOR CRRC AND LEED				
CRRC Description	Test Method	White	Gray	Tan
Initial solar reflectance	ASTM C1549	0.79	0.46	0.71
Solar reflectance after 3 years	ASTM C1549 (uncleaned)	0.70	0.43	0.64
Initial thermal emittance	ASTM C1371	0.90	0.89	0.86
Thermal emittance after 3 years	ASTM C1371 (uncleaned)	0.86	0.88	0.87
Thermal emittance	ASTM E408	0.90	0.88	0.86
SRI (Solar Reflectance Index)	ASTM E1980	99	53	86
SRI (Solar Reflectance Index) after 3 years	ASTM E1980	85	48	77
Product ID Number		0670-0009	0670-0017	0670-0016

Solar Reflectance Index (SRI) is calculated per ASTM E 1980. The SRI is a measure of the roof's ability to reject solar heat, as shown by a small temperature rise. It is defined so that a standard black (reflectance 0.05, emittance 0.90) is 0 and a standard white (reflectance 0.80, emittance 0.90) is 100. Materials with the highest SRI values are the coolest choices for roofing. Due to the way SRI is defined, particularly hot materials can even take slightly negative values, and particularly cool materials can even exceed 100.

RADIATIVE PROPERTIES (INITIAL) FOR COLORWAY COLORS			
Color	Reflectance	Emittance	SRI
Medium Bronze	0.28	0.86	29
Rock Brown	0.25	0.87	26
Slate Gray	0.38	0.87	42
Terra Cotta	0.25	0.86	25
Patina Green	0.25	0.88	25

LEED INFORMATION	
Pre-consumer Recycled Content	10%
Post-consumer Recycled Content	0%
Manufacturing Location	Senatobia, MS Tooele, UT Carlisle, PA
Solar Reflectance Index (SRI)	99 (white) 86 (tan)

PROTECTION & SAFETY

MuleHide maintains safety data sheets on all of its non-exempt products. Safety data sheets contain health and safety information for your development of appropriate product handling procedures to protect your employees and customers. MuleHide's safety data sheets should be read and understood by all of your supervisory personnel and employees before using MuleHide products in your facilities.



TPO-C Membrane (Standard, FR & Clean Film)

Polyester Reinforced, Heat-Weldable Membrane

PRODUCT DATA SHEET

TYPICAL PHYSICAL PROPERTIES					
Physical Properties*	Test Method	Requirement	45-mil	60-mil	80-mil
Thickness tolerance on nominal, %	ASTM D751	±15, -10	±10	±10	±10
Thickness over scrim, in. (mm) (average of 3 areas)	ASTM D6878 (Optical Method)	0.015 min. (0.380)	0.018 typical (0.457)	0.024 typical (0.610)	0.034 typical (0.864)
Breaking strength, lbf (kN)	ASTM D751 (Grab Method)	220 (976 N) minimum	225 (1.0) min. 320 (1.4) typical	250 (1.1) min. 360 (1.6) typical	350 (1.6) min. 425 (1.9) typical
Elongation at break of fabric, %	ASTM D751 (Grab Method)	15 minimum	15 minimum 25 typical	15 minimum 25 typical	15 minimum 25 typical
Tear strength, lbf (N) 8 by 8 in. specimen	ASTM D751 (B Tongue Tear)	55 (245) minimum	55 (245) min. 130 (578) typical	55 (245) min. 130 (578) typical	55 (245) min. 130 (578) typical
Brittleness point, °F (°C)	ASTM D2137	-40 (-40) maximum	-40°F (-40°C) max -50°F (-46°C) typical	-40°F (-40°C) max -50°F (-46°C) typical	-40°F (-40°C) max -50°F (-46°C) typical
Linear dimensional change (shrinkage) % change	ASTM D1204 6 hrs at 158°F (70°C)	±1 maximum	±1 max -0.2 typical	±1 max -0.2 typical	±1 max -0.2 typical
Ozone resistance, 100 pphm, 168 hrs.	ASTM D1149	PASS	PASS	PASS	PASS
UV exposure (Xenon Arc), no cracks 7 x min. exposure 10,080 kJ/m ² (4,000 hrs - 0.70W/m ²)	ASTM G155	PASS	PASS	PASS	PASS
Factory seam strength, lbf/in (kN/m)	ASTM D751	66 (290) min	66 (290) minimum	66 (290) minimum	66 (290) minimum
Field seam strength, lbf/in (kN/m) Seams tested in peel	ASTM D1876	No requirement	25 (4.4) min. 50 (8.8) typical	25 (4.4) min. 60 (10.5) typical	40 (7.0) min. 70 (12.3) typical
Water vapor permeance, Perms	ASTM E96 proc. B	No requirement	0.10 max. 0.05 typical	0.10 max. 0.05 typical	0.10 max. 0.05 typical
Water absorption resistance, mass % top surface only @ 158F, 166 hours	ASTM D471	No requirement	3.0 max. 0.90 typical	3.0 max. 0.90 typical	3.0 max. 0.90 typical
Puncture resistance, lbf (N)	FTM 101C (Method 2031)	No requirement	250 (1.1) min. 325 (1.4) typical	300 (1.3) min. 350 (1.6) typical	400 (1.8) min. 450 (2.0) typical
Properties after heat aging	ASTM D573, 32 weeks at 240°F or 8 weeks at 275°F No cracking when bent around 3" dia. Madrel Weight change, %	PASS No Cracking ±1.0 max	PASS No Cracking ±1.0 max	PASS No Cracking ±1.0 max	PASS No Cracking ±1.0 max
Typical weights lb/ft ² (kg/m ²)	N/A	N/A	0.25	0.33	0.45
Air Permeance	ASTM E2178	No Requirement	Pass	Pass	Pass

*Typical properties and characteristics are based on samples tested and are not guaranteed for all samples of this product. This data and information is intended as a guide and does not reflect the specification range for any particular property of this product.

ADDITIONAL INFORMATION

On projects where a MuleHide Standard or Premium Warranty is requested, an authorized MuleHide representative shall inspect all completed work.

The information given on this PDS is subject to change without notice. Always check the MuleHide website at www.mulehide.com for the latest information, changes and updates or contact MuleHide at 800-786-1492.

DISCLAIMER

The statements provided concerning the material shown are intended as a guide for material usage and are believed to be true and accurate at the time of printing. No statement made by anyone may supersede this information, except when done in writing by Mule-Hide Products Co., Inc. ("MuleHide"). Since the manner of use is beyond our control, MuleHide does not authorize anyone to make any warranty of merchantability or fitness for any particular purpose or any other warranty, guarantee or representation, expressed or implied, concerning this material. This product may be eligible for a MuleHide warranty, please check the MuleHide website at www.mulehide.com or contact MuleHide directly at 800-786-1492 for details. Buyer and user accept the product under these conditions and assume the risk of any failure, any injury to person or property (including that of the user), loss or liability resulting from the handling, storage or use of the product whether or not it is handled, stored or used in accordance with the directions or specifications. MuleHide must be notified in writing of any claims and be given the opportunity to inspect the alleged failure before repairs are made.



MULE-HIDE HDP (#14) FASTENERS

PRODUCT DESCRIPTION

Rev. May 2020

Mule-Hide Heavy-Duty Drill Point Fasteners are # 14 fasteners that are specifically engineered to attached insulation, cover boards and base sheets to wood and steel decking (16 to 22 gauge). These fasteners incorporate a No. 3 Phillips recess, flat truss head with a #2 double flute self-drilling point. The drill point has an exclusive tapered entry thread design that allows for fastener penetration into steel roof decks and offers exceptional back-out resistance.

BASIC USES

Mule-Hide's HDP Fasteners are designed specifically for the mechanical attachment of Mule-Hide's reinforced EPDM, TPO and PVC membranes and for the mechanical attachment of Poly ISO 1 and Poly ISO 2 roof insulation boards and other FM approved insulation / cover boards into steel, wood and concrete decks. The Mule-Hide HDP Fasteners may be used in conjunction with the Mule-Hide 2.4" Seam Plates, 3" Insulation Plates and All Purpose Bars. Refer to Mule-Hide's appropriate Single-Ply Manuals for installation instructions and uses.



SPECIFICATIONS

Property	Standard	Average Ultimate Value
Wire:	----	SAE C-1022, heat treated wire
Coating:	----	TRU-Kote™ Epoxy E-Coat
Corrosion Resistance	FM 4470, ASTM D6294, DIN 50018	<15% Red Rust after 30 cycles
Tensile Strength	ASTM F606-10	3200 lbf.
Shear Strength	NASM 1312-20	2200 lb. (thread zone)

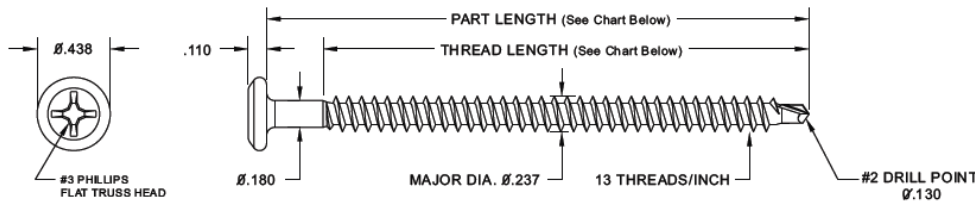

PACKAGING

Screw Length*	Thread Length*	Pieces/Box	Weight/Box
1-1/2"	1-1/2"	1000	12.9 lbs
2"	2"	1000	15.5 lbs
2-1/2"	2-1/2"	1000	19.4 lbs
3"	2-7/8"	1000	23.7 lbs
3-1/2"	2-7/8"	1000	26.4 lbs
4"	3-7/8"	1000	30.9 lbs
4-1/2"	3-7/8"	1000	33.6 lbs
5"	3-7/8"	1000	37.3 lbs
5-1/2"	3-7/8"	1000	40.8 lbs
6"	3-7/8"	1000	44.0 lbs
7"	3-7/8"	500	25.9 lbs
8"	3-7/8"	500	29.7 lbs
9"	3-7/8"	250	16.6 lbs
10"	3-7/8"	250	18.5 lbs
11"	3-7/8"	250	20.1 lbs
12"	3-7/8"	250	22.0 lbs

*Notes: Screw Length is ± 1/16" Thread Length is ± 1/16"

MULE-HIDE HDP (#14) FASTENERS

Performance Information

Average Ultimate Pullout Values in Corrugated Steel Deck Substrates															
Thickness	24 ga.			22 ga.			20 ga.			18 ga.			16 ga.		
Strength, ksi	36.5	33.0	80.0	102.0	33.0	80.0	102.0	33.0	80.0	102.0	33.0	80.0	102.0		
Pullout (lbs)	255	315	480	560	420	615	710	675	885	985	850	1115	1240		

Average Ultimate Pullout Values in Wood Substrates									Concrete	
Type	APA Rated OSB				APA Rated Plywood				SPF #2	3,000 psi
Thickness	7/16"	15/32"	19/32"	23/32"	15/32"	19/32"	23/32"			
Pullout (lbs)	270	290	310	410	360	410	730	795*	450*	

- *lbf./in. of thread penetration including tip.
- Pull out values are offered only as a guide and are not guaranteed in any way.
- Designated holding powers are dependent upon quality of substrate and accuracy of installation.
- Mule-Hide recommends that fastener pull out testing be performed to verify fastener performance.

CODE APPROVALS/COMPLIANCE

Mule-Hide HDP Fasteners comply with the requirements of the following specifications, test and code requirements when properly installed. FM Standard 4450/4470 Approved, Metro-Dade Approved, Florida Product Approvals.

LEED® Information	
Manufacturing Location	Bryan, OH
LEED Eligible Recycle Content	20%

INSTALLATION INSTRUCTIONS

Steel and Wood Decks

Install fasteners with #3 Phillips drive bit provided in box and a variable speed screw gun. Fastener must penetrate the deck a minimum of 3/4" as measured from the underside of the roof deck to the fastener tip. Ensure that fastener is installed perpendicular to surface of roof deck. Care should be taken to not overdrive the fastener causing damage to roof insulation, fastener or roof deck.

Concrete Decks

Pre-drill a 3/16" diameter hole using a drill bit that meets ANSI Standard B212.15 requirements and hammer drill. Drill hole a minimum of 1/2" deeper than fastener embedment and clean debris from hole. Using the #3 Phillips drill bit provided and a 0 to 1500 rpm screw gun, install fastener to a minimum embedment of 1" until fastener head is properly seated in bar or plate. Care should be taken to not overdrive the fastener causing damage to roof insulation, fastener or roof deck. **Use eye protection when installing fasteners.**

PROTECTION & SAFETY

Mule-Hide maintains Safety Data Sheets on all of its non-exempt products. Safety Data Sheets contain health and safety information for your development of appropriate product handling procedures to protect your employees and customers. Mule-Hide's Safety Data Sheets should be read and understood by all of your supervisory personnel and employees before using Mule-Hide products in your facilities.

ADDITIONAL INFORMATION

The information given on this PDS is subject to change without notice. Always check the Mule-Hide website at www.mulehide.com for the latest information, changes and updates or contact Mule-Hide Products Company at 800-786-1492.

DISCLAIMER

The statements provided concerning the material shown are intended as a guide for material usage and are believed to be true and accurate at the time of printing. No statement made by anyone may supersede this information, except when done in writing by Mule-Hide Products Co., Inc. Since the manner of use is beyond our control, Mule-Hide does not authorize anyone to make any warranty of merchantability or fitness for any particular purpose or any other warranty, guarantee or representation, expressed or implied, concerning this material. This product may be eligible for a Mule-Hide warranty, please check the Mule-Hide website at www.mulehide.com or contact Mule-Hide directly at 800-786-1492 for details. Buyer and user accept the product under these conditions and assume the risk of any failure, any injury person or property (including that of the user), loss or liability resulting from the handling, storage or use of the product whether or not it is handled, stored or used in accordance with the directions or specifications. Mule-Hide must be notified in writing of any claims and be given the opportunity to inspect the alleged failure before repairs are made.



Product Data Sheet

LOW-VOC BONDING ADHESIVE

PRODUCT DESCRIPTION

Low-VOC Bonding Adhesive is a high strength solvent-based contact adhesive that allows bonding of EPDM and TPO membrane to various porous and non-porous substrates. It is specially formulated using a blend of VOC exempt and non-exempt solvents to meet the < 250 g/l VOC content requirements of the OTC Model Rule for Single Ply Roofing Adhesives. Low-VOC Bonding Adhesive is easily applied with a 9" (228 mm) medium nap roller to create a strong bond between the membrane and approved substrate.

This product does not comply with the following California counties' VOC regulations: Alameda, Contra Costa, El Dorado, Los Angeles, Marin, Napa, Orange, Riverside, Sacramento, San Bernardino, San Diego, San Francisco, San Mateo, Santa Clara, Solano, Sonoma, and Tehama. These areas require the use of Mule-Hide Low-VOC 1168 Bonding Adhesive.



BASIC USES

Mule-Hide Bonding Adhesive is used for bonding (cured) flashings and membranes to a variety of substrates.

TYPICAL PHYSICAL PROPERTIES

Typical values*	
Base Material	Synthetic Rubber
Color	Yellow
Solids	22%
VOC:	250 g/l max
Flash Point	0° F (-17° C) Closed Cup
Brookfield Viscosity	3,500 Centipoises
Avg Net Weight	8 lbs. / gallon (0.96 kg/l)
Packaging	5 Gallon Pails & 1 Gallon Cans
Shelf Life	1 Year

LEED Information	
Pre-consumer Recycled Content	0%
Post-consumer Recycled Content	0%
Manufacturing Location	Carlisle, PA
VOC Content	< 250 g/l

*General properties. Typical properties and characteristics are based on samples tested and are not guaranteed for all samples of this product. This data and information is intended as a guide and does not reflect the specification or specification range for any particular property of this product.

PACKAGING

Packaged in 5 gallon pails and 1 gallon cans

BENEFITS & SUPPLEMENTAL STATEMENTS

- High strength adhesive with quick bonding characteristics
- Ease of application with a medium nap roller
- Provides excellent adhesion between TPO or EPDM membranes and a variety of substrates
- Extended open time

CODE APPROVALS/COMPLIANCE

A variety of Factory Mutual Ratings and Underwriter Laboratory Classifications are available. Contact Mule-Hide Technical Department for additional information.

Product Data Sheet

LOW-VOC BONDING ADHESIVE

COVERAGE RATES

Coverage for Low-VOC Bonding Adhesive is approximately 60 ft² (5.6 square m) per gallon (finished surface.) A 5-gallon pail should cover no more than 300 square feet (28 m² of finished area. This coverage rate is an average and may vary due to conditions on the job site. Porous wall substrates such as masonry block may require two coats of bonding adhesive. In these cases, allow the first coat of adhesive to flash off completely prior to applying the second coat of adhesive at the required coverage rate of 60 square feet per gallon.

INSTALLATION TEMPERATURE

If adhesive is stored below freezing temperatures, restore to room temperature for a minimum of 24 hours prior to use. Keep adhesive warm (60°F to 90°F, 15°C to 32°C) for ease of application.

INSTALLATION INSTRUCTIONS

Surface Preparation

The surface, on or against which adhesive is to be applied, shall be clean, smooth, dry, free of fins, sharp edges, loose and foreign materials, oil and grease. Depressions greater than 1/4" (6 mm) should be feathered; using epoxy, mortar or other approved patching material. All sharp projections shall be removed by sweeping, blowing or vacuum cleaning.

Mixing

Stir Low-VOC Bonding Adhesive thoroughly once per day until all settled polymers are dispersed and the adhesive is a uniform yellow color. During mixing, scrape the sides and bottom of the pail until the adhesive is a uniform yellow color with no dark streaks. Keeping the adhesive warm, as well as using an air-operated mixing paddle, will aid in the mixing process.

Application

1. Allow membrane to relax for half an hour or longer. Allowing the membrane to relax will result in the roof's surface having a smoother appearance. This is especially true for sheets that have folds or creases.
2. After the Low-VOC Bonding Adhesive has been thoroughly mixed, apply to the substrate and membrane using a 9" (228 mm) medium nap roller. Application shall be continuous and uniform, avoiding globs or puddles that could result in solvent blisters. Heavy "wet" areas can be re-rolled to break the skin, allowing the solvents to flash off. The solvents in Low-VOC Bonding Adhesive must be allowed to flash-off until the adhesive does not string or transfer to a dry finger touch, but remains tacky. This is called the "tack test". It's recommended to continually monitor the adhesive for flash-off after the application of the adhesive. **Install the membrane after the adhesive passes the tack test to avoid trapped solvent blisters. In hot weather, flash-off time can occur in as little as 5 minutes or less. Temperature, sun, shade or humidity can affect flash-off time.** Any coated area, which has been exposed to rain, should be allowed to dry and then recoated. **Do not apply adhesive to seam areas or use with taped products.**
3. Roll the membrane onto the adhesive-coated substrate while avoiding wrinkles. Immediately brush down the bonded portion of the sheet with a stiff-bristle push broom to achieve maximum contact. For wall applications, use a neoprene type hand roller after brooming to ensure maximum contact. If blisters occur from trapped solvent, allow the solvent to naturally dissipate for 4 or 5 days and then re-roll or re-broom the membrane so it lays flat.

REVIEW CURRENT MULE-HIDE SPECIFICATIONS AND DETAILS FOR ADDITIONAL INFORMATION.

Product Data Sheet

LOW-VOC BONDING ADHESIVE

Precautions

1. Review the applicable Material Safety Data Sheet for complete safety information prior to use.
2. Low-VOC Bonding Adhesive must be stored in original, unopened containers at temperatures between 60°F (15°C) and 90°F (32°C). Jobsite storage in excess of 90°F (32°C) may affect product shelf life.
3. Prolonged exposure to below freezing temperatures will cause the adhesive to thicken and solidify in the can. Should the Low-VOC Bonding Adhesive be stored at temperatures lower than 25°F (-4°C), restore to room temperature for a minimum of 24 hours prior to use. Adhesive will perform as intended once it is returned to a liquid state. When temperatures are expected to be consistently below 40°F (4°C), a heated enclosure or hot box is required for storage. Keep the adhesive warm (60-90°F) for ease of application.
4. Low-VOC Bonding Adhesive is **EXTREMELY FLAMMABLE** -It contains solvents that are dangerous fire and explosion hazards when exposed to heat, flame or sparks. Do not smoke while applying. Do not use in a confined or unventilated area. Vapors are heavier than air and may travel along ground or may be moved by ventilation and ignited by pilot lights, other flames, sparks, heaters, smoking, electrical motors, static discharge, or other ignition sources at locations distant from material handling point and flashback. All containers should be grounded when material is transferred from one container to another. A red caution label is required when shipping. A fire extinguisher should be available. In case of fire, use water spray, foam, dry chemical or carbon dioxide. Do not use a solid stream of water because it can scatter and spread the fire.
5. Avoid breathing vapors. Keep container closed when not in use. Use with adequate ventilation. If inhaled, remove to fresh air. If not breathing, perform artificial respiration. If breathing is difficult, give oxygen. Call a physician immediately. During application, efforts must be made to prevent fumes from entering the building via air ventilation ducts. Do not place open containers or mix adhesive near fresh air intake units. When possible, shut down or seal off the closest units.
6. If swallowed, **DO NOT INDUCE VOMITING**. Call a physician immediately.
7. Avoid contact with skin. Wash hands thoroughly after handling. In case of contact with skin, thoroughly wash affected area with soap and water. Contact physician if irritation persists. **Note:** Permeation resistant gloves (that meet ANSI/ISEA 105-2005) are recommended to be worn when using this product to protect hands from irritating ingredients.
8. Avoid contact with eyes. Safety glasses or goggles are recommended. If splashed in eyes, immediately flush eyes with plenty of clean water for at least 15 minutes. Contact a physician immediately.
9. Do not thin Low-VOC Bonding Adhesive. Thinning will affect performance. Excessively thick or gelled material should be discarded.
10. These materials are sensitive to ambient moisture and heat will accelerate the effect of moisture. Opened containers of bonding adhesive should be used within 48 hours. Adhesive will begin to thicken after this point, making it difficult, and eventually impossible, to control adhesive thickness.
11. Adhesive must be allowed to flash-off but not become over dry. If membrane is mated with the substrate prior to the adhesive being dry, blistering will occur. If membrane is mated with the substrate after the adhesive has over-dried, loose or unadhered areas will occur. Thin application of adhesive increases risk of over-drying.
12. Coverage rates are an average and may vary due to jobsite conditions.
13. **KEEP OUT OF THE REACH OF CHILDREN**

Product Data Sheet

LOW-VOC BONDING ADHESIVE

STORAGE & HANDLING

Job site storage in excess of 90°F (32°C) may affect product shelf life. Should the Low-VOC Bonding Adhesive be stored at temperatures lower than 60°F (15°C), restore to room temperature prior to use.

Prolonged exposure to below freezing temperatures will cause the adhesive to thicken and solidify in the can. Should the Low-VOC Bonding Adhesive be stored at temperatures lower than 25°F (-4°C), restore to room temperature for a minimum of 24 hours prior to use. Adhesive will perform as intended once it is returned to a liquid state. When temperatures are expected to be consistently below 40°F (4°C), a heated enclosure or hot box is required for storage. Keep the adhesive warm (60-90°F) for ease of application.

PROTECTION & SAFETY

Mule-Hide maintains Material Safety Data Sheets on all of its products. Material Safety Data Sheets contain health and safety information for your development of appropriate product handling procedures to protect your employees and customers. Mule-Hide's Material Safety Data Sheets should be read and understood by all of your supervisory personnel and employees before using Mule-Hide products in your facilities.

ADDITIONAL INFORMATION

The information given on this PDS is subject to change without notice. Always check the Mule-Hide website at www.mulehide.com for the latest information, changes and updates or contact Mule-Hide Products Company at 800-786-1492.

DISCLAIMER

The statements provided concerning the material shown are intended as a guide for material usage and are believed to be true and accurate at the time of printing. No statement made by anyone may supersede this information, except when done in writing by Mule-Hide Products Co., Inc. Since the manner of use is beyond our control, Mule-Hide does not authorize anyone to make any warranty of merchantability or fitness for any particular purpose or any other warranty, guarantee or representation, expressed or implied, concerning this material. This product may be eligible for a Mule-Hide warranty, please check the Mule-Hide website at www.mulehide.com or contact Mule-Hide directly at 800-786-1492 for details. Buyer and user accept the product under these conditions and assume the risk of any failure, any injury person or property (including that of the user), loss or liability resulting from the handling, storage or use of the product whether or not it is handled, stored or used in accordance with the directions or specifications. Mule-Hide must be notified in writing of any claims and be given the opportunity to inspect the alleged failure before repairs are made.



AeroWeb

Low-VOC Aerosol Contact Adhesive



PRODUCT DATA SHEET



ACCEPTABLE MEMBRANES AND APPLICATIONS

Membrane	Wall	Field
TPO	Yes	Yes
EPDM	Yes	Yes*
PVC	No	No
Fleece Back**	Yes	No

*Contact Mule-Hide Technical Department for project requirements

**Not for use with TPO Fleece Back FR

PACKAGING

PRODUCT	SIZE/WEIGHT
AeroWeb	#40 Aerosol Cylinder Fill Weight: 30 lbs. of Adhesive
6' Hose	6' Length
12' Hose	12' Length
18' Hose	18' Length
Spray Gun Adjustable	--
Spray Gun with 24" Extension	--
Low-VOC Un-Tack	#8 Aerosol Cylinder

Important Note: AeroWeb, Low-VOC Un-Tack, hoses and gun are each sold separately.

DESCRIPTION

Mule-Hide's AeroWeb Low-VOC Aerosol Contact Adhesive/Primer can be used for a variety of applications: adhering Fleece Back, Standard TPO, and EPDM membrane to vertical walls, enhancing the bond between Mule-Hide's F5 and various substrates, and priming unexposed asphalt prior to applying Helix Adhesive for insulation attachment.

AeroWeb's Low-VOC, methylene chloride-free formula promotes tenacious adhesion and quick drying in a wide range of temperatures. Applied using a self-contained spray system that provides quick and even coverage, this system requires minimal cleanup or maintenance.

Please note: cylinder, hoses, and gun are each sold separately.

PRODUCTIVITY BOOSTING FEATURES AND BENEFITS

- Quick application with spray gun
- Fast tack time
- No stirring
- Up to 60% labor savings compared to traditional bonding adhesive

FEATURES AND BENEFITS

- Adhering Fleece Back (vertical application only)
- Can be used in temperatures as low as 25°F when used as an adhesive
- Can be used in temperatures as low as 15°F when used as a primer
- Easy setup
- Easy cleanup
- Low odor and Low-VOC

INSTALLATION INSTRUCTIONS

1. Connect spray gun to hose and connect hose to cylinder. Use lithium grease or petroleum jelly on all fittings and be careful to avoid cross-threading. Open valve on cylinder to check fittings for leaks. Keep cylinder valve open to maintain pressure in the hose/spray gun when not in use.
2. AeroWeb can be applied at ambient temperature of 25°F and above. Propellant in cylinders must be kept above 70°F for the product to spray properly. Utilize power-heated blanket, and hot boxes when necessary. Substrate shall be clean, dry, and free of debris and contaminants.
3. For applications taking place in ambient temperature below 70°F, store cylinders in heated space and move to project area during application. Cylinders must be kept warm on the jobsite. Dispense product from cylinder while it is still warm. When product in cylinder becomes too cold, it will begin to spit rather than spray. If this occurs, swap cold cylinder for warmer one and return cold cylinder to heated area. When changing cylinder, close the valve on the cylinder and depressurize the hose. Remove the hose and attach to the new cylinder. Open valve and do a test spray.
4. Apply AeroWeb in an even coat to substrate (refer to the drawing on the next page), keeping the spray tip approximately 12" (30.5 cm) away and perpendicular to the surface during spray. Avoid high thickness buildup.



AeroWeb

Low-VOC Aerosol Contact Adhesive



PRODUCT DATA SHEET

5. Allow AeroWeb to flash-off until it does not transfer to finger when touched. Limit application of AeroWeb to surfaces that will be covered with membrane or Mule-Hide's F5 the same day.

Vertical Applications of Standard TPO & EPDM membrane, or any Fleece Back membrane*:

(*Note: Not for use with TPO Fleece Back FR)

Acceptable substrates include: Mule-Hide Poly ISO roof insulation, Poly ISO 1-HD, DensDeck® Prime, SECUROCK®, OSB, plywood, metal, residual asphalt, and clean concrete block. To improve adhesion and reduce the potential for asphalt bleed-through on vertical surfaces with residual asphalt, apply an initial "sealing" base coat of AeroWeb and allow to flash off properly; then, apply a secondary coating of AeroWeb to the vertical surface.

There are no height restrictions when using AeroWeb for vertical applications if the appropriate membrane terminations are utilized.

1. Spray wall and back of the membrane, utilizing a 50% overlapping spray pattern.
2. Do not apply adhesive to splice areas.
3. Allow adhesive to become tacky but not overly dry; it should not transfer to fingers when touched.
4. Mate membrane with the wall from the center of the sheet towards the edges, smoothing by hand.
5. Broom the membrane with a soft-bristle broom.
6. Roll in with a hand roller.

Horizontal Application of Standard TPO, Standard EPDM and White-on-Black EPDM membranes

Acceptable substrates include: Mule-Hide Poly ISO roof insulation, Poly ISO 1-HD, DensDeck Prime, SECUROCK, OSB, and plywood. Please see Mule-Hide's TPO Specification for a complete list of acceptable substrates.

The surface, on or against which adhesive is to be applied, shall be clean, smooth, dry, free of films, sharp edges, loose and foreign materials, oil and grease. Depressions greater than 1/4" (6 mm) should be feathered, using epoxy, mortar or other approved patching material. All sharp projections shall be removed by sweeping, blowing or vacuum cleaning.

Application shall be continuous and uniform, avoiding globs or puddles.

1. Spray substrate and back of the membrane with enough overlap to ensure 100% coverage (2"-3" of overlap).
2. Do not apply adhesive to splice areas.
3. Allow adhesive to become tacky but not overly dry; it should not transfer to fingers when touched.
4. Roll the membrane onto the adhesive-coated substrate while avoiding wrinkles. Immediately brush down the bonded portion of the sheet with a soft-bristle push broom, and then roll the membrane with a clean, dry roller (minimum 75 lb. to maximum 150 lb.) to achieve maximum contact.

Review Mule-Hide specifications and details for complete installation information.

CLEAN UP

UN-TACK™ safe solvent or mineral spirits can be used to clean tools and surfaces. If the spray gun valve becomes stuck, attach hose and spray gun to cylinder of Citrus Cleaner or UN-TACK and trigger spray gun repeatedly until operation is smooth. If the spray gun is clogged, a small-gauge wire or torch clean-out tool is helpful after soaking the brass fitting in UN-TACK.

STORAGE AND HANDLING

Store cylinders in protected, conditioned space with temperature maintained above 70°F. Do not store cylinders in areas where temperatures reach 110°F or higher. Contents are flammable. Store in accordance with local, state, and federal regulations. Keep cylinder valve open to maintain pressure in the hose and spray gun. Periodically spray in a safe manner to help prevent possible clogging. Keep spray gun trigger locked when not in use. Flush gun and hose with UN-TACK for long-term storage beyond 30 days.

TYPICAL PROPERTIES AND CHARACTERISTICS	
PHYSICAL PROPERTY	TYPICAL VALUE
Color	Light Green
Consistency	Aerosol Spray
Spray Pattern	Variable Web
Odor	Low
Base	Rubber/Solvent Blend
Solvent	Cyclohexane/Acetone
Coverage Rate	1-Sided Primer - 2,000-2,500 ft ² when used with air and vapor barriers* 2-Sided Adhesive - Walls - 1,000ft ² * 2-Sided Adhesive - Field - 1,000ft ² *
Tack Time	5 minutes**
Adhesion	Excellent
Service Temperature	-30°F-200°F (-34°C to 93°C)
Flammability	Flammable when wet. Non-flammable when dry.
Water Resistance	Excellent
Midew Resistance	Excellent
Shelf Life	12 months (unopened container)

*Approximate Coverage
**or longer depending on climate conditions

LEED INFORMATION	
Pre-consumer Recycled Content	0%
Post-consumer Recycled Content	0%
Manufacturing Location	Lynchburg, VA
VOC	248 g/L



AeroWeb

Low-VOC Aerosol Contact Adhesive



PRODUCT DATA SHEET

PRECAUTIONS

AeroWeb is a flammable liquid propellant and vapor. Vapors are heavier than air and may travel along the ground or may be moved by ventilation and ignited by pilot lights, other flames, sparks, heaters, smoking, electrical motors, static discharge, or other ignition sources at locations distant from the material handling point and flashback. Keep away from open flame. Use with adequate ventilation. Avoid inhalation of spray mist or vapors. Harmful or fatal if swallowed. May cause eye irritation. Keep out of reach of children. Review Safety Data Sheet for complete safety information prior to use. Use of goggles and gloves is required. Aerosol cylinders are not refillable and when empty are harmless and disposable. Dispose according to local codes and laws. Read safety precautions and warnings on cylinder label. Wear gloves and goggles before using this product. Do not aim spray gun at people or animals at any time. PPE Gloves must be used while handling material.

CYLINDER DISPOSAL

When all adhesive in the cylinder has been used, close cylinder valve and evacuate hose and spray gun before disconnecting hose from cylinder. If hose is not to be connected to a new cylinder immediately, do not evacuate hose and spray gun to ensure material does not harden in spray gun and hose. Clean up adhesive residue, spray gun, and spray tips with PVC UN-TACK or mineral spirits. In most areas, the empty cylinder can be disposed as an aerosol can or recycled as scrap metal. If disposal is not allowed in your area, contact your distributor for disposal arrangements. Federal law forbids transportation if refilled.

PROTECTION & SAFETY

Mule-Hide maintains Safety Data Sheets on all of its non-exempt products. Safety Data Sheets contain health and safety information for your development of appropriate product handling procedures to protect your employees and customers. Mule-Hide's Safety Data Sheets should be read and understood by all of your supervisory personnel and employees before using Mule-Hide products in your facilities.

For industrial professional use only.

ADDITIONAL INFORMATION

On projects where a Mule-Hide Standard or Premium Warranty is requested, an authorized Mule-hide representative shall inspect all completed work.

The information given on this PDS is subject to change without notice. Always check the Mule-Hide website at www.mulehide.com for the latest information, changes and updates or contact Mule-Hide Products Company at 800-786-1492.

DISCLAIMER

The statements provided concerning the material shown are intended as a guide for material usage and are believed to be true and accurate at the time of printing. No statement made by anyone may supersede this information, except when done in writing by Mule-Hide Products Co., Inc. Since the manner of use is beyond our control, Mule-Hide does not authorize anyone to make any warranty of merchantability or fitness for any particular purpose or any other warranty, guarantee or representation, expressed or implied, concerning this material. This product may be eligible for a Mule-Hide warranty, please check the Mule-Hide website at www.mulehide.com or contact Mule-Hide directly at 800-786-1492 for details. Buyer and user accept the product under these conditions and assume the risk of any failure, any injury person or property (including that of the user), loss or liability resulting from the handling, storage or use of the product whether or not it is handled, stored or used in accordance with the directions or specifications. Mule-Hide must be notified in writing of any claims and be given the opportunity to inspect the alleged failure before repairs are made.



Product Data Sheet

MULE-HIDE TPO-c BONDING ADHESIVE

PRODUCT DESCRIPTION

Mule-Hide TPO-c Bonding Adhesive is a high strength solvent-based contact adhesive that allows bonding of Mule-Hide membrane to various porous and non-porous substrates.

BASIC USES

Mule-Hide TPO-c Bonding Adhesive is used for bonding cured flashings and membranes to a variety of substrates.



TYPICAL PHYSICAL PROPERTIES*

Typical Properties and Characteristics*	
Base Material	Synthetic Rubber
Color	Yellow
Solids	20%
Flash Point	-4° F (-20° C) Closed Cup
Brookfield Viscosity	2,600 Centipoises
Avg Net Weight	7.1 lbs. / gallon (3.2 Kg)
Packaging	5 Gallon Pails
Shelf Life	1 Year

LEED Information	
Pre-consumer Recycled Content	0%
Post-consumer Recycled Content	0%
Manufacturing Location	Carlisle, PA
VOC Content	670 g/L

*Typical properties and characteristics are based on samples tested and are not guaranteed for all samples of this product. This data and information is intended as a guide and does not reflect the specification or specification range for any particular property of this product.

PACKAGING AND STORAGE

DOT Label Required: Flammable Liquid - Mule-Hide TPO-c Bonding Adhesive should be stored in a closed container between 60°F and 80°F for no longer than one year. Rotate stock.

BENEFITS

- Can be roller applied with a medium nap roller
- Solvent based bonding adhesive that allows for quick drying
- Provides excellent adhesion to various substrates

CODE APPROVALS/COMPLIANCE

A variety of Factory Mutual Ratings and Underwriter Laboratory Classifications are available. Contact Mule-Hide Technical Department for additional information.

COVERAGE RATES

Coverage for Mule-Hide TPO-c Bonding Adhesive is approximately 60 ft² (5.6 square m) per gallon (finished surface.) This coverage rate is an average and may vary due to conditions on the job site. Porous surfaces and substrates may require more bonding adhesive than the typical coverage rate.

INSTALLATION TEMPERATURE

If adhesive is store at temperatures less than 60° F, restore to room temperature (~70° F) before using.

Product Data Sheet

MULE-HIDE TPO-c BONDING ADHESIVE

INSTALLATION INSTRUCTIONS

Surface Preparation

1. The surface, on or against which adhesive is to be applied, shall be clean, smooth, dry, free of fins, sharp edges, loose and foreign materials, oil and grease. Depressions greater than 1/4" (6 mm) should be feathered; using epoxy, mortar or other approved patching material. All sharp projections shall be removed by sweeping, blowing or vacuum cleaning.

Mixing

1. **Stir thoroughly until all settled pigments are dispersed and the adhesive is uniform in color. Stir adhesive for a minimum of 5 minutes.**

Application

1. After thorough stirring (minimum 5 minutes), apply TPO-c Bonding Adhesive to substrate and membrane using a 9" (228 mm) wide, 1/2" (13mm) medium nap roller. Application shall be continuous and uniform avoiding globs or puddles. An open time of 5 to 50 minutes, based on drying conditions is recommended before assembly. TPO-c Bonding Adhesive must be allowed to dry until tacky but does not string or stick to a dry finger touch. Any coated area, which has been exposed to rain, should be allowed to dry and then recoated. **Do not apply adhesive to seam areas or use with taped products.**
2. Roll the membrane onto the adhesive coated substrate while avoiding wrinkles. Immediately brush down the bonded portion of the sheet with a soft bristle push broom or a clean dry roller applicator to achieve maximum contact. Adhesive must be allowed to dry thoroughly. If membrane is mated with the substrate prior to the adhesive being dry, blistering will occur and will not subside over time.

Review current Mule-Hide specifications and details for additional information.

Precautions

1. Review the applicable Material Safety Data Sheet for complete safety information prior to use.
2. Mule-Hide Bonding Adhesive is **EXTREMELY FLAMMABLE** -It contains solvents that are dangerous fire and explosion hazards when exposed to heat, flame or sparks. Do not smoke while applying. Do not use in a confined or unventilated area. Vapors are heavier than air and may travel along ground or may be moved by ventilation and ignited by pilot lights, other flames, sparks, heaters, smoking, electrical motors, static discharge, or other ignition sources at locations distant from material handling point and flashback. All containers should be grounded when material is transferred from one container to another. A red caution label is required when shipping. A fire extinguisher should be available. In case of fire, use water spray, foam, dry chemical or carbon dioxide. Do not use a solid stream of water because it can scatter and spread the fire.
3. Avoid breathing vapors. Keep container closed when not in use. Use with adequate ventilation. If inhaled, remove to fresh air. If not breathing, perform artificial respiration. If breathing is difficult, give oxygen. Call a physician immediately. During application, efforts must be made to prevent fumes from entering the building via air ventilation ducts. Do not place open containers or mix adhesive near fresh air intake units. When possible, shut down or seal off the closest units.
4. If swallowed, **DO NOT INDUCE VOMITING**. Call a physician immediately.
5. Avoid contact with skin. Wash hands thoroughly after handling. In case of contact with skin, thoroughly wash affected area with soap and water. Contact physician if irritation persists. **Note:** Permeation resistant gloves (that meet ANSI/ISEA 105-2005) are recommended to be worn when using this product to protect hands from irritating ingredients.

Product Data Sheet

MULE-HIDE TPO-c BONDING ADHESIVE

Precautions (Continued)

6. Avoid contact with eyes. Safety glasses or goggles are recommended. If splashed in eyes, immediately flush eyes with plenty of clean water for at least 15 minutes. Contact a physician immediately.
7. Do not thin TPO-c Bonding Adhesive. Thinning will affect performance. Excessively thick or gelled material should be discarded.
8. These materials are sensitive to ambient moisture and heat will accelerate the effect of moisture. Opened containers of Bonding Adhesive should be used within 48 hours. Adhesive will begin to thicken after this point, making it difficult and eventually impossible, to control adhesive thickness. In hot weather, do leave sealed containers on roof for prolonged periods of time. In cold weather, keep material at room temperature until ready to use. Stir adhesive occasionally while using.
9. Adhesive must be allowed to dry thoroughly. If membrane is mated with the substrate prior to the adhesive being dry, blistering will occur and will not subside over time.
10. Coverage rates are an average and may vary due to jobsite conditions.
11. KEEP OUT OF THE REACH OF CHILDREN

STORAGE & HANDLING

Job site storage in excess of 90°F (32°C) may affect product shelf life. Should the Mule-Hide Bonding Adhesive be stored at temperatures lower than 60°F (15°C), restore to room temperature prior to use.

PROTECTION & SAFETY

Mule-Hide maintains Safety Data Sheets on all of its non-exempt products. Safety Data Sheets contain health and safety information for your development of appropriate product handling procedures to protect your employees and customers. Mule-Hide's Safety Data Sheets should be read and understood by all of your supervisory personnel and employees before using Mule-Hide products in your facilities.

ADDITIONAL INFORMATION

The information given on this PDS is subject to change without notice. Always check the Mule-Hide website at www.mulehide.com for the latest information, changes and updates or contact Mule-Hide Products Company at 800-786-1492.

DISCLAIMER

The statements provided concerning the material shown are intended as a guide for material usage and are believed to be true and accurate at the time of printing. No statement made by anyone may supersede this information, except when done in writing by Mule-Hide Products Co., Inc. Since the manner of use is beyond our control, Mule-Hide does not authorize anyone to make any warranty of merchantability or fitness for any particular purpose or any other warranty, guarantee or representation, expressed or implied, concerning this material. Buyer and user accept the product under these conditions and assume the risk of any failure, any injury person or property (including that of the user), loss or liability resulting from the handling, storage or use of the product whether or not it is handled, stored or used in accordance with the directions or specifications. Mule-Hide must be notified in writing of any claims and be given the opportunity to inspect the alleged failure before repairs are made.



Product Data Sheet

TPO FLASHING (.060 NON-REINFORCED)

PRODUCT DESCRIPTION

Revision Date: July 2019

TPO Flashing is a .060" (60 mil) thick (nominal), non-reinforced TPO (polyolefin-based) membrane.

BASIC USES

TPO Flashing is primarily used to seal details where field fabrication is necessary, such as drain details, pipe flashings, pitch pocket flashings, seaming joints of the TPO Coated Metal, and any place where reinforced membrane is not practical.



SPECIFICATIONS

Typical Properties and Characteristics*		
Property	ASTM Test Method	Specification
Tolerance on nominal thickness	D 412	+15% / -10%
Weight, typical		0.30 lb/ft ² (1.5 kg/m ²)
Elongation	D 412 Die C	600%
Tear strength	D 624 Die C	250 lbf/in (43.8 kN/m)
Tensile strength	D 412 Die C	1200 psi (8.3 Mpa)
Ozone resistance, 168 hr @ 100 pphm, 50% ext	D 1149	No cracks
Heat aging: 28 days @ 240°F (116°C)	D 573	
- Tensile strength, minimum	D 412	1000 psi (6.9 MPa)
- Elongation, ultimate	D 412	500%
- Tear strength, minimum	D624	200 lbf/in (35.0 kN/m)
- Linear dimensional change, maximum	D 1204	±4%
Resistance to Xenon-arc weathering	G26	No cracks
- Xenon-Arc, 5040 kJ/m ² total radiant	0.70 W/m ²	
- Exposure, visual condition at 10X	80°C B.P.T.	

* Typical properties and characteristics are based on samples tested and are not guaranteed for all samples of this product. This data and information is intended as a guide and does not reflect the specification or specification range for any particular property of this product.

LEED Information	
Pre-consumer Recycled Content	0%
Post-consumer Recycled Content	0%
Manufacturing Location	Greenville, IL
Solar Reflectance Index (SRI)	N/A

COLORS

Standard Colors: White, Gray and Tan

Colorway Colors: Medium Bronze, Patina Green, Rock Brown, Slate Gray and Terra Cotta

BENEFITS & SUPPLEMENTAL STATEMENTS

- Improved TPO flashing provides additional flexibility making field fabricated details easier to form
- Contains same superior weathering package as Mule-Hide TPO membranes
- Excellent weldability allows for consistent, high-quality seams in details and other critical roof areas

Product Data Sheet

TPO FLASHING (0.060 NON-REINFORCED)

PACKAGING

- Standard Colors - 12" x 50' rolls, 1 roll per carton, 17 lbs
24" x 50' rolls, 1 roll per carton, 33 lbs
- Colorway Colors - 24" x 50' rolls, 1 roll per carton, 33 lbs

INSTALLATION INSTRUCTIONS

1. TPO Flashing is used to flash a variety of roofing structures and penetrations and specific installation methods will vary. Refer to the appropriate Mule-Hide specification and/or detail for specific installation information.
2. A lower heat setting is required on the heat welder when hot air welding the un-reinforced flashing membrane. A typical starting setting is 6, on a scale of 1 to 10.
3. Use the edge of the roller to crease the flashing into any membrane step-offs to achieve a proper seal.

PRECAUTIONS

1. Review the applicable Safety Data Sheet for complete safety information prior to use.
2. UV filtering sunglasses are strongly recommended when working with Mule-Hide TPO roofing systems.
3. Store TPO Flashing in a cool, shaded area and cover with light-colored, breathable, waterproof tarpaulins.
4. TPO Flashing material that has been exposed to the weather for approximately 7 days or longer prior to use must be prepared with Weather Membrane Cleaner prior to hot-air welding.

PROTECTION & SAFETY

Mule-Hide maintains Safety Data Sheets on all of its non-exempt products. Safety Data Sheets contain health and safety information for your development of appropriate product handling procedures to protect your employees and customers. Mule-Hide Safety Data Sheets should be read and understood by all of your supervisory personnel and employees before using Mule-Hide products in your facilities.

ADDITIONAL INFORMATION

The information given on this PDS is subject to change without notice. Always check the Mule-Hide website at www.mulehide.com for the latest information, changes and updates or contact Mule-Hide Products Company at 800-786-1492.

DISCLAIMER

The statements provided concerning the material shown are intended as a guide for material usage and are believed to be true and accurate at the time of printing. No statement made by anyone may supersede this information, except when done in writing by Mule-Hide Products Co., Inc. Since the manner of use is beyond our control, Mule-Hide does not authorize anyone to make any warranty of merchantability or fitness for any particular purpose or any other warranty, guarantee or representation, expressed or implied, concerning this material. Buyer and user accept the product under these conditions and assume the risk of any failure, any injury person or property (including that of the user), loss or liability resulting from the handling, storage or use of the product whether or not it is handled, stored or used in accordance with the directions or specifications. Mule-Hide must be notified in writing of any claims and be given the opportunity to inspect the alleged failure before repairs are made.



Product Data Sheet

MULE-HIDE TPO COVER STRIP

PRODUCT DESCRIPTION

Rev. Feb 2020

TPO Cover Strip is a nominal 30-mils (0.76 mm) thick non-reinforced TPO membrane laminated to a nominal 30-mil (0.76 mm) thick, fully cured synthetic rubber pressure sensitive adhesive. TPO Cover Strip is available in 6" wide (152 mm) x 100' (30.5 m) long rolls and in three colors – white, gray and tan.



BASIC USES

TPO Cover Strip is intended to strip in flat metal flanges (i.e. drip edge) and is limited to maximum 20-year warranty coverage. TPO Cover Strips *cannot* be used for flashing corners, pipes, T-joints, butt joints, seams, or any angled metal flanges such as gravel stops or other canted metal edgings.

SPECIFICATIONS

Typical Properties and Characteristics*		
Colors	White, Tan and gray	
Tensile Strength, psi (MPa)	ASTM D412	2,500 (17.2) minimum 2,900 (20.0) typical
Elongation, %	ASTM D412	600 minimum 750 typical
Hardness, Shore A	ASTM D2240	Typical 80
Base	Membrane – Non-reinforced TPO Adhesive – Synthetic Rubber with clear release liner	
Solids	100%	
Nominal Thickness:	0.060" (1.52 mm)	
Nominal Width	Membrane – 6" (152 mm) Adhesive – 6 1/4" (159 mm)	
Nominal Length	100 ft (30.5 m)	
Net Weight per Roll	22 lbs (10 kg)	
Shelf Life	One year	
* Typical properties and characteristics are based on samples tested and are not guaranteed for all samples of this product. This data and information is intended as a guide and does not reflect the specification range for any particular property of this product.		

LEED Information	
Pre-consumer Recycled Content	0%
Post-consumer Recycled Content	0%
Manufacturing Location	Michigan Center, MI
Solar Reflectance Index (SRI)	N/A

PACKAGING

2 rolls per carton
22 lbs (10 kg) per roll

BENEFITS & SUPPLEMENTAL STATEMENTS

- Adhesive is compatible with a variety of metal finishes
- Offers fast, easy installation with no welding

Product Data Sheet

MULE-HIDE TPO COVER STRIP

INSTALLATION TEMPERATURE

If product is exposed to cold temperatures restore to room temperature (~60°F (15°C)) prior to use.

INSTALLATION INSTRUCTIONS

1. Clean the existing membrane (and metal if applicable) with Weathered Membrane Cleaner and natural fiber rags. A Scotch-Brite® Pad may be necessary to remove a heavy build-up of dirt. Pour a small amount of Weathered Membrane Cleaner over a primer pad and rub area to be flashed in a circular motion. Wipe away residual dirt with clean rags
2. Using a clean Scotch-Brite® Pad, apply Tape Primer to the area of the membrane to be flashed. The properly primed area will be uniform in color without streaks and free of globs or puddles.
3. The entire surface where the flashing will be applied must be clean. The adhesive on the back of the TPO Cover Strip will not adhere to dusted/dirty surfaces. Any residual surface contamination will be detrimental to the bond strength of the adhesive.
4. Install cover strip immediately after the Tape Primer flashes off to minimize potential dust contamination and to promote adhesion in colder weather.
5. Peel off 10-12" (250-300 mm) of the protective release liner from the TPO Cover Strip. Position the flashing over the area to be covered and press down using firm, even hand pressure across the entire area. Continue this process until the full area to be flashed is completed. (Cut-Edge Sealant is not required along edges of the TPO Cover Strip).
6. Immediately roll the TPO Cover Strip with a 2" (50-mm) wide neoprene roller using positive pressure. Roll across the cover strip edge, not parallel to it. **In areas where the TPO Cover Strip crosses a metal joint, a membrane seam (T-joint) or at an end lap use a hot air gun to heat the top surface (TPO membrane) of the TPO Cover Strip and crease the material into the step-off.** This process reduces the possibility of a water channel forming.
7. To achieve proper adhesion of the TPO Cover Strip when job site temperatures fall below 40°F (5°C), heat the cleaned/primed area of the membrane with a hot air gun as the flashing is applied and pressed into place.

Review Mule-Hide specifications and details for additional information.

PRECAUTIONS

1. TPO Cover Strip cannot be used for flashing corners, pipes, T-Joints, butt joints, or any angled metal flanges such as canted metal edging.
2. Avoid prolonged contact with skin. In case of contact with skin, thoroughly wash affected area with soap and water.
3. Prolonged job site storage temperatures in excess of 90° F (32° C) may affect product shelf life.
4. In warm sunny weather, keep TPO Cover Strip in original packaging or in a shaded area prior to use.
5. TPO Cover Strip must be stored in a dry area.
6. Due to solvent flash-off, condensation may form on freshly applied Tape Primer when the ambient temperature is near the dew point. If condensation develops, the application of Tape Primer and TPO Cover Strip must be stopped since proper adhesion will not be achieved. Allow the affected surface to dry and apply a thin freshening coat of Tape Primer to the previously (affected) coated surface and apply TPO Cover Strip when conditions allow.
7. Do not allow waste products (petroleum, grease, oil, solvents, vegetable or mineral oil, animal fats, etc.) or direct steam venting to come in contact with the TPO Cover Strip.
8. KEEP OUT OF REACH OF CHILDREN

STORAGE & HANDLING

Storage and use of TPO Cover Strip at temperatures below 40°F (4° C) will result in a loss of adhesive tack, and in extreme cases, will result in no bond to the substrate. Overnight storage must be available to keep the temperature of the TPO Cover Strip at a minimum of 60° F (15° C). Hot boxes for job site storage must be provided to maintain a minimum product temperature of 40° F (4° C).

Product Data Sheet

MULE-HIDE TPO COVER STRIP

PROTECTION & SAFETY

Mule-Hide maintains Safety Data Sheets on all of its non-exempt products. Safety Data Sheets contain health and safety information for your development of appropriate product handling procedures to protect your employees and customers. Mule-Hide's Safety Data Sheets should be read and understood by all of your supervisory personnel and employees before using Mule-Hide products in your facilities.

ADDITIONAL INFORMATION

The information given on this PDS is subject to change without notice. Always check the Mule-Hide website at www.mulehide.com for the latest information, changes and updates or contact Mule-Hide Products Company at 800-786-1492.

DISCLAIMER

The statements provided concerning the material shown are intended as a guide for material usage and are believed to be true and accurate at the time of printing. No statement made by anyone may supersede this information, except when done in writing by Mule-Hide Products Co., Inc. Since the manner of use is beyond our control, Mule-Hide does not authorize anyone to make any warranty of merchantability or fitness for any particular purpose or any other warranty, guarantee or representation, expressed or implied, concerning this material. Buyer and user accept the product under these conditions and assume the risk of any failure, any injury person or property (including that of the user), loss or liability resulting from the handling, storage or use of the product whether or not it is handled, stored or used in accordance with the directions or specifications. Mule-Hide must be notified in writing of any claims and be given the opportunity to inspect the alleged failure before repairs are made.



Product Data Sheet

MULE-HIDE TAPE PRIMER

PRODUCT DESCRIPTION

Mule-Hide Tape Primer is a solvent-based product designed for one-step cleaning and priming of EPDM surfaces to be bonded with In-Seam Tapes, Uncured Flashing Tapes, Cured Cover Tapes, and Pre-Taped membranes.

BASIC USES

A product designed for priming of EPDM surfaces prior to the application of Taped Products. Also used with EPDM for application of In-Seam Tapes.

TYPICAL PHYSICAL PROPERTIES*

Physical Properties*	
Base Material	Synthetic Rubber
Solids	18%
Flash Point	40°F (4.4°C)
Shelf Life	12 months
Average Weight	7.3 lbs./gallon (0.9 kg/liter)
*General properties. Typical properties and characteristics are based on samples tested and are not guaranteed for all samples of this product. This data and information is intended as a guide and does not reflect the specification or specification range for any particular property of this product.	



COLOR

Olive Drab to Dark Gray

PACKAGING

(6) 1 gallon (3.8 liter) cans per carton, or (8) 1 quart (0.95 liter) screw top cans per carton

BENEFITS & SUPPLEMENTAL STATEMENTS

Promotes excellent adhesion with Tape Products
One step cleaner and primer when used on pre-cleaned sheets

COVERAGE RATES

Approximately 250 square feet / gallon on standard EPDM (dusted).
Coverage rates as high as 450 square feet on Pre-Cleaned Membrane or standard membrane that is first cleaned with Weathered Membrane Cleaner.

LEED INFORMATION

LEED® Information	
Pre-consumer Recycled Content	0%
Post-consumer Recycled Content	0%
Manufacturing Location	Carlisle, PA
VOC Content	714 g/L



MULE-HIDE TAPE PRIMER

INSTALLATION TEMPERATURE

If primer is stored at temperatures less than 60° F, restore to room temperature (~70° F) before using.

INSTALLATION INSTRUCTIONS

Surface Preparation

1. Remove all foreign material by brooming or washing with water. If membrane is very dirty, scrubbing with Weathered Membrane Cleaner may be necessary. This process is essential on membrane that has been exposed for a number of weeks.

Note: Permeation resistant gloves (that meet ANSI/ISEA 105-2005) are required for hand protection when cleaners or primers are being used.

Application

1. Thoroughly stir primer until all settled materials are blended into the solution.
2. Dusted Membrane:

Option 1: Apply the primer with Scotch-Brite® pads or clean rags. Scrub the area of the membrane (where the Pre-Taped Sheet, Taped Product or Splicing Cement is to be applied) in a circular motion to achieve a thin, even coating on the membrane. The properly cleaned/primed area will be uniform in color without streaks and free of globs or puddles.

Option 2: Clean the surface of the membrane to be primed with clean rags and Weathered Membrane Cleaner. Change rags often to ensure mica dust is removed. Roller apply the primer to the membrane with a short nap-length paint roller. The coated area must be free of globs or puddles.

3. Pre-Cleaned Membrane: Roller apply the primer to the membrane with a short nap-length paint roller. The coated area must be free of globs or puddles.
4. Note: The use of excessive amounts of Mule-Hide Tape Primer will not significantly enhance the adhesion of the Pre-Taped or Taped Product to the EPDM membrane. Use only the amount necessary to obtain 100% coverage of the area where the tape or adhesive will be applied.
5. Allow the Mule-Hide Tape Primer to dry until it does not transfer to a dry finger touch. Prompt installation of the In-Seam Tape or Taped Product as soon as the primer flashes off minimizes potential dust contamination and promotes adhesion in colder weather.
6. Complete the splice as specified in Mule-Hide's Specifications and Details.

** REVIEW CURRENT MULE-HIDE SPECIFICATIONS AND DETAILS FOR SPECIFIC APPLICATION REQUIREMENTS.

Precautions

1. This product is FLAMMABLE. Precautions must be taken to keep the primer away from heat, flame and sparks during storage and use.



Product Data Sheet

MULE-HIDE TAPE PRIMER

2. Avoid contact with eyes and skin.
3. Avoid breathing vapors. Keep container closed when not in use. Use with adequate ventilation. If inhaled, remove to fresh air. If not breathing, perform artificial respiration. If breathing is difficult, give oxygen. Call a physician immediately. During application, efforts must be made to prevent fumes from entering the building via air ventilation ducts. Do not place open containers or mix adhesive near fresh air intake units. When possible, shut down or seal off the closest units.
4. If swallowed, DO NOT INDUCE VOMITING. Call a physician immediately.
5. Chemically-resistant gloves must be worn with Mule-Hide Tape Primer to protect hands from staining and irritating ingredients.
6. Thoroughly stir this product until all settled pigment is blended into the solution. Solids suspended in Mule-Hide Tape Primer tend to settle. Use Mule-Hide Tape Primer full strength. Do not thin. Thinning will affect performance.
7. Mule-Hide Tape Primer may cause staining of White-on-Black membrane and other non-black surfaces.
8. Due to solvent flash-off, condensation may form on freshly applied Mule-Hide Tape Primer when the ambient temperature is near the dew point. If condensation develops, the application of primer must be discontinued (proper adhesion will not be obtained). Allow the surface to dry and apply a thin freshener coat of primer to the previously coated surface when conditions allow.

REVIEW THE MULE-HIDE EPDM PRIMER MATERIAL SAFETY DATA SHEET FOR COMPLETE SAFETY INFORMATION PRIOR TO USE.

KEEP OUT OF REACH OF CHILDREN.

STORAGE & HANDLING

Job site storage temperatures in excess of 90°F (32°C) may affect product shelf life. Should the primer be stored at temperatures lower than 60°F (15°C), restore to room temperature prior to use.

Keep can tightly closed when not in use and protect from moisture contamination. Once exposed to moisture in the air, Mule-Hide Tape Primer begins to cure and may gel within a few days. A gasket of membrane or sealant can be used to create a positive seal.

PROTECTION & SAFETY

Mule-Hide maintains Material Safety Data Sheets on all of its products. Material Safety Data Sheets contain health and safety information for your development of appropriate product handling procedures to protect your employees and customers. Mule-Hide's Material Safety Data Sheets should be read and understood by all of your supervisory personnel and employees before using Mule-Hide products in your facilities.



Product Data Sheet

MULE-HIDE TAPE PRIMER

ADDITIONAL INFORMATION

The information given on this PDS is subject to change without notice. Always check the Mule-Hide website at www.mulehide.com for the latest information, changes and updates or contact Mule-Hide Products Company at 800-786-1492.

DISCLAIMER

The statements provided concerning the material shown are intended as a guide for material usage and are believed to be true and accurate at the time of printing. No statement made by anyone may supersede this information, except when done in writing by Mule-Hide Products Co., Inc. Since the manner of use is beyond our control, Mule-Hide does not authorize anyone to make any warranty of merchantability or fitness for any particular purpose or any other warranty, guarantee or representation, expressed or implied, concerning this material. This product may be eligible for a Mule-Hide warranty, please check the Mule-Hide website at www.mulehide.com or contact Mule-Hide directly at 800-786-1492 for details. Buyer and user accept the product under these conditions and assume the risk of any failure, any injury person or property (including that of the user), loss or liability resulting from the handling, storage or use of the product whether or not it is handled, stored or used in accordance with the directions or specifications. Mule-Hide must be notified in writing of any claims and be given the opportunity to inspect the alleged failure before repairs are made.



Product Data Sheet

LOW VOC PRIMER

PRODUCT DESCRIPTION

Low VOC Primer is a solvent-based product designed for one-step cleaning and priming of EPDM and TPO surfaces to be bonded with In-Seam Tapes, Uncured Flashing Tapes, Cured Cover Tapes, and Pre-Taped membranes. It is a Low VOC product that is ideal for use where environmental concerns are an issue.

BASIC USES

A Low VOC product designed for one-step cleaning and priming of EPDM and TPO surfaces prior to the application of In-Seam Tapes and other Taped Products.



TYPICAL PHYSICAL PROPERTIES*

Typical Properties and Characteristics	
Base Material	Synthetic Rubber
Color	Olive Drab
Solids	9%
Flash Point	40°F (4.4°C)
Shelf Life	9 months
Average Weight	9.55 lbs./gallon (1.14 kg/liter)

Leed Information	
Pre-consumer Recycled Content	0%
Post-consumer Recycled Content	0%
Manufacturing Location	Carlisle, PA
VOC Content	<250 g/l

*General properties. Typical properties and characteristics are based on samples tested and are not guaranteed for all samples of this product. This data and information is intended as a guide and does not reflect the specification or specification range for any particular property of this product.

PACKAGING

(6) 1 gallon (3.8 liter) cans per carton

BENEFITS & SUPPLEMENTAL STATEMENTS

- Promotes excellent long term adhesion with Tape Products
- One step cleaner and primer for EPDM and TPO membranes
- VOC less than 250 g/l

COVERAGE RATES

Approximately 250 square feet / gallon with Dusted Sheet
Approximately 700 square feet / gallon with TPO

INSTALLATION TEMPERATURE

If primer is store at temperatures less than 60° F, restore to room temperature (~70° F) before using.

MIXING

Mixing is not recommended, even when settling has occurred. The Low-VOC Primer contains a non-partitioning agent that may settle to the bottom of the can. Do not attempt to break up or stir back into the primer.

Product Data Sheet

Low VOC PRIMER

INSTALLATION INSTRUCTIONS

Surface Preparation

1. Remove all foreign material by brooming or washing with water. If membrane is very dirty, scrubbing with Weathered Membrane Cleaner may be necessary. This process is essential on membrane that has been exposed for a number of weeks.

Note: Permeation resistant gloves (that meet ANSI/ISEA 105-2005) are required for hand protection when cleaners or primers are being used.

Application

1. **Mixing is not recommended, even when settling has occurred.**
2. Apply the primer with Scotch-Brite® pads or clean rags. Scrub the area of the membrane (where the Pre-Taped Sheet, Taped Product or Splicing Cement is to be applied) in a circular motion to achieve a thin, even coating on the membrane. The properly cleaned/primed area will be uniform in color without streaks and free of globs or puddles.
3. Note: The use of excessive amounts of Low VOC Primer will not significantly enhance the adhesion of the Pre-Taped or Taped Product to the EPDM or TPO membrane. Use only the amount necessary to obtain 100% coverage of the area where the tape or adhesive will be applied.
4. Allow the Low VOC Primer to dry until it does not transfer to a dry finger touch. Prompt installation of the In-Seam Tape or Taped Product as soon as the primer flashes off minimizes potential dust contamination and promotes adhesion in colder weather.
5. Complete the splice as specified in Mule-Hide's Specifications and Details.

Review current Mule-Hide specifications and details for additional information.

Precautions

1. Do not allow primer to over dry or lose tack.
2. Install taped products immediately after primer flashes off and while primer is still tacky.
3. This product is **FLAMMABLE**. Precautions must be taken to keep the primer away from heat, flame and sparks during storage and use.
4. Avoid contact with eyes and skin.
5. Avoid breathing vapors. Keep container closed when not in use. Use with adequate ventilation. If inhaled, remove to fresh air. If not breathing, perform artificial respiration. If breathing is difficult, give oxygen. Call a physician immediately. During application, efforts must be made to prevent fumes from entering the building via air ventilation ducts. Do not place open containers or mix adhesive near fresh air intake units. When possible, shut down or seal off the closest units.
6. If swallowed, **DO NOT INDUCE VOMITING**. Call a physician immediately.
7. Chemically-resistant gloves must be worn with Low VOC Primer to protect hands from staining and irritating ingredients.
8. Solids suspended in Low VOC Primer tend to settle and **DO NOT NEED TO BE REMIXED**. Stirring is not required. Use Low VOC Primer full strength. Do not thin. Thinning will affect performance.
7. Low VOC Primer is not white in color and may cause staining of White-on-Black membrane and other non-black surfaces. For appearance, care should be taken to limit the amount of primer exposed beyond the splice area.
8. Due to solvent flash-off, condensation may form on freshly applied Low VOC Primer when the ambient temperature is near the dew point. If condensation develops, the application of primer must be discontinued (proper adhesion will not be obtained). Allow the surface to dry and apply a thin freshener coat of primer to the previously coated surface when conditions allow.

REVIEW THE LOW VOC PRIMER MATERIAL SAFETY DATA SHEET FOR COMPLETE SAFETY INFORMATION PRIOR TO USE. **KEEP OUT OF REACH OF CHILDREN.**

Product Data Sheet

Low VOC PRIMER

STORAGE & HANDLING

Job site storage temperatures in excess of 90°F (32°C) may affect product shelf life. Should the primer be stored at temperatures lower than 60°F (15°C), restore to room temperature prior to use.

Keep can tightly closed when not in use and protect from moisture contamination. Once exposed to moisture in the air, Low VOC Primer begins to cure and may gel within a few days. A gasket of membrane or sealant can be used to create a positive seal.

PROTECTION & SAFETY

Mule-Hide maintains Safety Data Sheets on all of its non-exempt products. Safety Data Sheets contain health and safety information for your development of appropriate product handling procedures to protect your employees and customers. Mule-Hide's Safety Data Sheets should be read and understood by all of your supervisory personnel and employees before using Mule-Hide products in your facilities.

ADDITIONAL INFORMATION

The information given on this PDS is subject to change without notice. Always check the Mule-Hide website at www.mulehide.com for the latest information, changes and updates or contact Mule-Hide Products Company at 800-786-1492.

DISCLAIMER

The statements provided concerning the material shown are intended as a guide for material usage and are believed to be true and accurate at the time of printing. No statement made by anyone may supersede this information, except when done in writing by Mule-Hide Products Co., Inc. Since the manner of use is beyond our control, Mule-Hide does not authorize anyone to make any warranty of merchantability or fitness for any particular purpose or any other warranty, guarantee or representation, expressed or implied, concerning this material. Buyer and user accept the product under these conditions and assume the risk of any failure, any injury person or property (including that of the user), loss or liability resulting from the handling, storage or use of the product whether or not it is handled, stored or used in accordance with the directions or specifications. Mule-Hide must be notified in writing of any claims and be given the opportunity to inspect the alleged failure before repairs are made.



TPO T-JOINT COVERS

PRODUCT DESCRIPTION

TPO T-Joint Covers are made from 60-mil non-reinforced flashing cut into a 4.5" diameter circle.

BASIC USES

TPO T-Joint Covers are used to seal step-offs at splice intersections. Installation is mandatory on all 60-mil and 80-mil TPO systems and on 45-mil systems where step-offs have not been properly sealed.

Revision Date: July 2019



TYPICAL PHYSICAL PROPERTIES

Standard Colors	White, Gray & Tan
Colorway Colors	Medium Bronze, Patina Green, Rock Brown, Slate Gray & Terra Cotta
Material	Non-reinforced TPO
Thickness	.060" (1.52mm)
Packaging	100 pieces per box
Weight	3.5 lbs (1.6 kg) per box
Size	4.5" (114 mm) diameter

*Typical properties and characteristics are based on samples tested and are not guaranteed for all samples of this product. This data and information is intended as a guide and does not reflect the specification range for any particular property of this product.

BENEFITS

- More consistent performance compared to hand cutting
- Every T-Joint Cover is a perfect 4.5" diameter circle
- Offers labor savings compared to hand cut flashings
- Seals channels at splice intersections created by seam step-offs

INSTALLATION INSTRUCTIONS

1. If membrane has been exposed to the weather, clean splice intersection area with Weathered Membrane Cleaner.
2. Use a lower temperature setting on the hand heat welder than that used for welding reinforced TPO membrane. (Typically a setting of "6" on a scale of "10" is appropriate for welding TPO T-Joint Covers.)
3. Center the T-Joint Cover over the splice intersection, begin welding at the center point and work toward the outside. Use the edge of the roller to crease the T-Joint Cover into membrane step-offs to achieve a proper seal.
4. Using a probe, check all splices for voids and cold welds only once the T-Joint Cover has completely cooled. Make any needed repairs.

Review Mule-Hide specifications and details for complete installation information.

PRECAUTIONS

- The TPO T-Joint Cover is not intended to overlay fasteners and plates as this requires the use of reinforced membrane.

TPO T-JOINT COVERS

STORAGE

T-Joint Covers should be stored in a clean, dry area and protected from extreme temperatures. TPO T-Joint Covers and TPO membrane that have been exposed to the weather prior to use must be prepared with Weathered Membrane Cleaner prior to hot-air welding.

PROTECTION & SAFETY

Mule-Hide maintains Safety Data Sheets on all of its non-exempt products. Safety Data Sheets contain health and safety information for your development of appropriate product handling procedures to protect your employees and customers. Mule-Hide Safety Data Sheets should be read and understood by all of your supervisory personnel and employees before using Mule-Hide products in your facilities.

ADDITIONAL INFORMATION

The information given on this PDS is subject to change without notice. Always check the Mule-Hide website at www.mulehide.com for the latest information, changes and updates or contact Mule-Hide Products Company at 800-786-1492.

DISCLAIMER

The statements provided concerning the material shown are intended as a guide for material usage and are believed to be true and accurate at the time of printing. No statement made by anyone may supersede this information, except when done in writing by Mule-Hide Products Co., Inc. Since the manner of use is beyond our control, Mule-Hide does not authorize anyone to make any warranty of merchantability or fitness for any particular purpose or any other warranty, guarantee or representation, expressed or implied, concerning this material. Buyer and user accept the product under these conditions and assume the risk of any failure, any injury person or property (including that of the user), loss or liability resulting from the handling, storage or use of the product whether or not it is handled, stored or used in accordance with the directions or specifications. Mule-Hide must be notified in writing of any claims and be given the opportunity to inspect the alleged failure before repairs are made.



TPO INSIDE CORNERS

PRODUCT DESCRIPTION

Revision Date: July 2019

Mule-Hide TPO Inside Corners are manufacturer from TPO (polyolefin) membrane.

BASIC USES

Mule-Hide TPO Inside Corners are uniform in shape and size and provide water tightness at inside corners formed by TPO coated metal and/or TPO flashing membrane. They provide a neat, finished look to building corners, and parapet flashings with no cutting required.

TYPICAL PHYSICAL PROPERTIES*

PHYSICAL PROPERTIES* - (Standard Colors)	
Standard Colors:	White, Gray & Tan
Material:	Non-reinforced TPO
Thickness:	.060" (1.52mm) thick molded material
Packaging:	12 pieces per bag

PHYSICAL PROPERTIES* - (Colorway Colors)	
Colorway Colors:	Medium Bronze, Patina Green, Rock Brown, Slate Gray & Terra Cotta
Material:	Reinforced TPO
Thickness:	.060" (1.52mm)
Packaging:	12 pieces per carton

*Typical properties and characteristics are based on samples tested and are not guaranteed for all samples of this product. This data and information is intended as a guide and does not reflect the specification range for any particular property of this product.

LEED Information	
Pre-consumer Recycled Content	0%
Post-consumer Recycled Content	0%
Manufacturing Location	Bloomington, IL
Solar Reflectance Index (SRI)	White: 99



Standard Color Inside Corner



Colorway Inside Corner

BENEFITS

- More consistent performance compared to hand cutting
- Forms easily to flash "out of square" corners that are not exactly 90 degrees
- Offers labor savings compared to hand cut flashings

INSTALLATION INSTRUCTIONS

1. If membrane has been exposed to the weather, clean splice intersection area with Weathered Membrane Cleaner.
2. Use a lower temperature setting on the hand heat welder than that used for welding reinforced TPO membrane. (Typically a setting of "6" on a scale of "10" is appropriate for welding TPO Inside Corners.)
3. Position TPO Inside Corner into the corner and begin welding at the innermost corner point and work away from the corner.

TPO INSIDE CORNERS

INSTALLATION INSTRUCTIONS (continued)

4. Use the roller edge to crease the corner flashing into any membrane step-off to create a proper seal.
5. Using a probe, check all splices for voids and cold welds only once the TPO Inside corner has completely cooled. Make any needed repairs.

Review Mule-Hide specifications and details for additional installation information.

STORAGE

Corners should be stored in a clean, dry area and protected from extreme temperatures. TPO Outside Corners, TPO membrane or TPO heat-welded accessories that have been exposed to the weather prior to use must be prepared with weathered membrane cleaner prior to hot-air welding.

PROTECTION & SAFETY

Mule-Hide maintains Safety Data Sheets on all of its non-exempt products. Safety Data Sheets contain health and safety information for your development of appropriate product handling procedures to protect your employees and customers. Mule-Hide Safety Data Sheets should be read and understood by all of your supervisory personnel and employees before using Mule-Hide products in your facilities.

ADDITIONAL INFORMATION

The information given on this PDS is subject to change without notice. Always check the Mule-Hide website at www.mulehide.com for the latest information, changes and updates or contact Mule-Hide Products Company at 800-786-1492.

DISCLAIMER

The statements provided concerning the material shown are intended as a guide for material usage and are believed to be true and accurate at the time of printing. No statement made by anyone may supersede this information, except when done in writing by Mule-Hide Products Co., Inc. Since the manner of use is beyond our control, Mule-Hide does not authorize anyone to make any warranty of merchantability or fitness for any particular purpose or any other warranty, guarantee or representation, expressed or implied, concerning this material. Buyer and user accept the product under these conditions and assume the risk of any failure, any injury person or property (including that of the user), loss or liability resulting from the handling, storage or use of the product whether or not it is handled, stored or used in accordance with the directions or specifications. Mule-Hide must be notified in writing of any claims and be given the opportunity to inspect the alleged failure before repairs are made.



TPO OUTSIDE CORNERS

PRODUCT DESCRIPTION

Revision Date: July 2019

TPO Outside Corners are manufactured from TPO (polyolefin) membrane.

BASIC USES

Mule-Hide TPO Outside Corners are uniform in shape and size and provide water tightness at outside corners formed by TPO coated metal and/or TPO flashing membrane. They provide a neat, finished look to building corners, curbs and parapet flashings with no cutting required.

TYPICAL PHYSICAL PROPERTIES*

PHYSICAL PROPERTIES* – (Standard Colors)	
Standard Colors:	White, Gray & Tan
Material:	Non-reinforced TPO
Thickness:	.060" (1.52mm) thick molded material
Packaging:	12 pieces per carton

PHYSICAL PROPERTIES* – (Colorway Colors)	
Colorway Colors:	Medium Bronze, Patina Green, Rock Brown, Slate Gray & Terra Cotta
Material:	Reinforced TPO
Thickness:	.060" (1.52mm)
Packaging:	12 pieces per carton

*Typical properties and characteristics are based on samples tested and are not guaranteed for all samples of this product. This data and information is intended as a guide and does not reflect the specification range for any particular property of this product.

LEED Information	
Pre-consumer Recycled Content	0%
Post-consumer Recycled Content	0%
Manufacturing Location	Bloomington, IL
Solar Reflectance Index (SRI)	White: 99

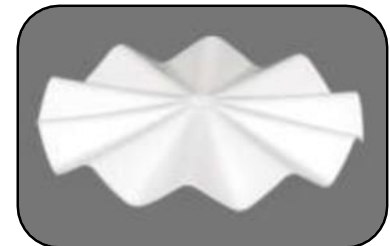

Standard Color Outside Corner



Colorway Outside Corner

BENEFITS

- More consistent performance compared to hand cutting
- Forms easily to flash “out of square” outside corners that are not exactly 90 degrees
- Offers labor savings compared to hand cut flashings

INSTALLATION INSTRUCTIONS

1. If membrane has been exposed to the weather, clean splice intersection area with Weathered Membrane Cleaner.
2. Use a lower temperature setting on the hand heat welder than that used for welding reinforced TPO membrane. (Typically a setting of “6” on a scale of “10” is appropriate for welding TPO Outside Corners.)
3. Position TPO Outside Corner over the outside intersection of the corner and begin welding at the innermost corner point and work away from the corner.
4. Use the roller edge to crease the corner flashing into any membrane step-off to create a proper seal.
5. Using a probe, check all splices for voids and cold welds only once the TPO Outside corner has completely cooled. Make any needed repairs.

Review Mule-Hide specifications and details for additional information.

TPO OUTSIDE CORNERS

STORAGE

Corners should be stored in a clean, dry area and protected from extreme temperatures. TPO Outside Corners, TPO membrane or TPO heat-welded accessories that have been exposed to the weather prior to use must be prepared with weathered membrane cleaner prior to hot-air welding.

PROTECTION & SAFETY

Mule-Hide maintains Safety Data Sheets on all of its non-exempt products. Safety Data Sheets contain health and safety information for your development of appropriate product handling procedures to protect your employees and customers. Mule-Hide Safety Data Sheets should be read and understood by all of your supervisory personnel and employees before using Mule-Hide products in your facilities.

ADDITIONAL INFORMATION

The information given on this PDS is subject to change without notice. Always check the Mule-Hide website at www.mulehide.com for the latest information, changes and updates or contact Mule-Hide Products Company at 800-786-1492.

DISCLAIMER

The statements provided concerning the material shown are intended as a guide for material usage and are believed to be true and accurate at the time of printing. No statement made by anyone may supersede this information, except when done in writing by Mule-Hide Products Co., Inc. Since the manner of use is beyond our control, Mule-Hide does not authorize anyone to make any warranty of merchantability or fitness for any particular purpose or any other warranty, guarantee or representation, expressed or implied, concerning this material. Buyer and user accept the product under these conditions and assume the risk of any failure, any injury person or property (including that of the user), loss or liability resulting from the handling, storage or use of the product whether or not it is handled, stored or used in accordance with the directions or specifications. Mule-Hide must be notified in writing of any claims and be given the opportunity to inspect the alleged failure before repairs are made.



Product Data Sheet

MULE-HIDE TPO UNIVERSAL CORNERS

PRODUCT DESCRIPTION

Mule-Hide TPO Universal Corners are pre-molded from non-reinforced TPO (polyolefin) membrane.

BASIC USES

Mule-Hide TPO Universal Corners are uniform in shape and size and provide water tightness at inside corners formed by TPO coated metal and/or TPO flashing membrane. They provide a neat, finished look to building corners, curbs and parapet flashings with no cutting required.



TYPICAL PHYSICAL PROPERTIES*

PHYSICAL PROPERTIES	
Color:	White
Material:	Injection-molded TPO
Thickness:	.060" (1.52mm) thick molded material
Packaging:	20 pieces per bag

LEED Information	
Pre-consumer Recycled Content	0%
Post-consumer Recycled Content	0%
Manufacturing Location	Bloomington, IL

*Typical properties and characteristics are based on samples tested and are not guaranteed for all samples of this product. This data and information is intended as a guide and does not reflect the specification range for any particular property of this product.

BENEFITS

- More consistent performance compared to hand cutting
- Each Universal Corner can be cut into one outside corner or one inside corner
- Large, 6" wide deck flange reduces the need for T-Joint
- Forms easily to flash "out of square" corners that are not exactly 90 degrees
- Offers labor savings compared to hand cut flashings

INSTALLATION INSTRUCTIONS

See diagram above for cutting instructions. Cutting lines and instructions are molded into each part. Use a lower temperature setting on the hand heat welder than that used for welding reinforced TPO field membrane. Typically a setting of 6 on a scale of 10 is appropriate for welding TPO Universal Corners.

Outside Corner

1. Clean surface to be welded with Weathered Membrane Cleaner.
2. Position the outside corner into position over the outside intersection of the corner.
3. Begin welding at the bottom point of the outside corner. Weld straight up the vertical portion of the corner. Weld each side of the outside corner, working from the inside toward the outside.
4. Weld the bottom flange starting on the inside and working towards the outer edges. Use the edge of the roller to crease the corner into any membrane step-off to create a proper seal.
5. Once the material has completely cooled, probe all welded edges of the corner to ensure watertight performance. Make any needed repairs.

Each Universal Corner can be cut into one Inside or Outside Corner.

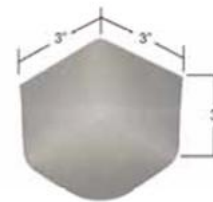

Inside Corner



Outside Corner

Product Data Sheet

MULE-HIDE TPO UNIVERSAL CORNERS

Inside Corner

1. Clean surface to be welded with Weathered Membrane Cleaner.
2. Position the inside corner into the corner setting. Begin welding at the innermost corner point and work up and away from the corner. Weld each side of the inside corner, working from inside to outside.
3. Weld the bottom flange starting on the inside and working towards the outer edges. Use the edge of the roller to crease the corner into any membrane step-off to create a proper seal.
4. Once the material has completely cooled, probe all welded edges of the corner to ensure watertight performance. Make any needed repairs.

Review Mule-Hide specifications and details for additional information.

STORAGE

Corners should be stored in a clean, dry area and protected from extreme temperatures.

TPO Outside Corners, TPO membrane or TPO heat-welded accessories that have been exposed to the weather prior to use must be prepared with weathered membrane cleaner prior to hot-air welding.

PROTECTION & SAFETY

Mule-Hide maintains Safety Data Sheets on all of its non-exempt products. Safety Data Sheets contain health and safety information for your development of appropriate product handling procedures to protect your employees and customers. Mule-Hide's Safety Data Sheets should be read and understood by all of your supervisory personnel and employees before using Mule-Hide products in your facilities.

ADDITIONAL INFORMATION

The information given on this PDS is subject to change without notice. Always check the Mule-Hide website at www.mulehide.com for the latest information, changes and updates or contact Mule-Hide Products Company at 800-786-1492.

DISCLAIMER

The statements provided concerning the material shown are intended as a guide for material usage and are believed to be true and accurate at the time of printing. No statement made by anyone may supersede this information, except when done in writing by Mule-Hide Products Co., Inc. Since the manner of use is beyond our control, Mule-Hide does not authorize anyone to make any warranty of merchantability or fitness for any particular purpose or any other warranty, guarantee or representation, expressed or implied, concerning this material. Buyer and user accept the product under these conditions and assume the risk of any failure, any injury person or property (including that of the user), loss or liability resulting from the handling, storage or use of the product whether or not it is handled, stored or used in accordance with the directions or specifications. Mule-Hide must be notified in writing of any claims and be given the opportunity to inspect the alleged failure before repairs are made.



Product Data Sheet

MULE-HIDE TPO PIPE SEALS

PRODUCT DESCRIPTION

Mule-Hide TPO Pipe Seals are an injection molded, pre-formed flashing for pipes made of Mule-Hide non-reinforced TPO material. They are designed to add ease to the installation process while offering increased watertight security and improved aesthetics.

BASIC USES

Mule-Hide TPO Pipe Seals are designed as an economical flashing for single pipe penetrations on Mule-Hide TPO-c Membrane roof systems. TPO Pipe Seals can be used wherever the TPO Pipe Seals may be slipped over the top of the pipe.



TYPICAL PHYSICAL PROPERTIES

Typical Properties and Characteristics*	
Sizes	3/4" to 8" od (19.0 to 203.2 mm)
Packaging	8 per box
Weight (each)	0.63 lbs (0.3 kg)
Material	Injection molded TPO
Color	White, gray and tan
Service Temp	Max 160°F (71°C)

LEED Information	
Pre-consumer recycled Content	0%
Post-consumer recycled Content	0%
Manufacturing Location	Bloomington, IL
Solar Reflectance Index (SRI)	N/A

*Typical properties and characteristics are based on samples tested and are not guaranteed for all samples of this product. This data and information is intended as a guide and does not reflect the specification or specification range for any particular property of this product.

BENEFITS & SUPPLEMENTAL STATEMENTS

Provides a reliable method of waterproofing round pipe penetrations. Offers substantial labor savings when compared to field fabrication.

INSTALLATION INSTRUCTIONS

1. Remove all existing lead and other flashings.
2. Temperature of pipe must not exceed 160°F (71°C)
3. Cut pipe seal to the desired diameter by cutting between two raised 'ribs' as illustrated on flange of pipe seal. (Do not cut off both raised 'ribs')
4. Pull pipe seal over pipe until base flange is in contact with the membrane. Top portion of pipe seal may be heated to facilitate installation.
5. Mark pipe around top of pipe seal.
6. Pull pipe seal upward until mark on pipe is visible.
7. For mechanically attached systems, install seam plates and fasteners at base of projection. Seam plates must fit inside flange of pipe seal.
8. Install Water Cut-off Mastic below mark on pipe.
9. Pull pipe seal back down over pipe and into position with flange contacting membrane.
10. Heat weld pipe seal to field membrane. Hand gun should be set between 6 and 7.
11. Install stainless steel clamping ring at top of pipe seal to ensure constant compression of the sealant. Do not over tighten clamp.

STORAGE & HANDLING

Store pre-molded pipe seals in a cool, shaded area and cover with a light-colored breathable, waterproof tarpaulin. Pipe seals that have been exposed to the elements must be prepared with weathered membrane cleaner prior to heat welding.

Product Data Sheet

MULE-HIDE TPO PIPE SEALS

PROTECTION & SAFETY

Mule-Hide maintains Safety Data Sheets on all of its non-exempt products. Safety Data Sheets contain health and safety information for your development of appropriate product handling procedures to protect your employees and customers. Mule-Hide's Safety Data Sheets should be read and understood by all of your supervisory personnel and employees before using Mule-Hide products in your facilities.

ADDITIONAL INFORMATION

Copper Tubing (C.T.S.)												
Nominal Tube Size	¾"	1"	1 ¼"	1 ½"	2"	2 ½"	3"	4"	5"	6"	8"	
Pipe O.D.	0.88	1.13	1.38	1.63	2.13	2.63	3.13	4.13	5.13	6.13	N/A	
Step of Boot Used	1	1	1	1 ½	2	2	3	4	5	6	N/A	
Schedule 40 / 80 Steep Pipe – PVC Standard – Polyethylene Pipe IPS												
Nominal Pipe Size	¾"	1"	1 ¼"	1 ½"	2"	2 ½"	3"	4"	5"	6"	8"	
Pipe O.D.	1.05	1.32	1.66	1.90	2.38	2.88	3.50	4.50	5.56	6.63	8.63	
Step of Boot Used	1	1	1 ½	1 ½	2	3	3	4	5	6	8	
Cast Iron Pipe		Pit Class A & Spun 100-250					Pit Class B, C & D					
Nominal Pipe Size	2"	3"	4"	6"	8"	2"	3"	4"	6"	8"		
Pipe O.D.	2.50	3.96	4.80	6.90	9.50	N/A	3.96	5.00	7.10	9.30		
Step of Boot Used	2	4	5	6	N/A	N/A	4	5	6	N/A		
Sewer Soil Pipe-PVC Plastic SFR 34 & 41-Cast Iron Soil Pipe no hub-service weight and extra heavy												
Nominal Pipe Size	4"				6"				8"			
Pipe O.D.	4.22 to 4.62				6.28 to 6.62				8.40 to 8.75			
Step of Boot Used	4				6				8			
Conduit EMT												
Nominal Pipe Size	¾"	1"	1 ¼"	1 ½"	2"	2 ½"	3"	3 ½"	4"			
Pipe O.D.	0.922	1.16	1.51	1.74	2.19	2.88	3.50	4.00	4.50			
Step of Boot Used	1	1	1	1 ½	2	3	3	4	4			
Conduit IMC												
Nominal Pipe Size	¾"	1"	1 ¼"	1 ½"	2"	2 ½"	3"	3 ½"	4"			
Pipe O.D.	1.02	1.29	1.63	1.88	2.36	2.85	3.47	3.97	4.46			
Step of Boot Used	1	1	1 ½	1 ½	2	3	3	4	4			
Conduit Rigid												
Nominal Pipe Size	¾"	1"	1 ¼"	1 ½"	2"	2 ½"	3"	3 ½"	4"	5"		
Pipe O.D.	1.05	1.32	1.66	1.90	2.37	2.87	3.50	4.00	4.50	5.56		
Step of Boot Used	1	1	1 ½	1 ½	2	3	3	4	4	5		

The information given on this PDS is subject to change without notice. Always check the Mule-Hide website at www.mulehide.com for the latest information, changes and updates or contact Mule-Hide Products Company at 800-786-1492.

DISCLAIMER

The statements provided concerning the material shown are intended as a guide for material usage and are believed to be true and accurate at the time of printing. No statement made by anyone may supersede this information, except when done in writing by Mule-Hide Products Co., Inc. Since the manner of use is beyond our control, Mule-Hide does not authorize anyone to make any warranty of merchantability or fitness for any particular purpose or any other warranty, guarantee or representation, expressed or implied, concerning this material. Buyer and user accept the product under these conditions and assume the risk of any failure, any injury person or property (including that of the user), loss or liability resulting from the handling, storage or use of the product whether or not it is handled, stored or used in accordance with the directions or specifications. Mule-Hide must be notified in writing of any claims and be given the opportunity to inspect the alleged failure before repairs are made.



TPO SPLIT PIPE BOOT

PRODUCT DESCRIPTION

TPO Split Pipe Boots are fabricated round flashings made of 60-mil TPO membrane. TPO Split Pipe Boots designed to fit pipes ranging in size from 1-inch (25.4 mm) to 6-inches (152.4 mm) and come with universal clamping rings. They are designed to add ease to the installation process while offering increased watertight security and improved aesthetics.

BASIC USES

The TPO Split Pipe Boots contains a split (cut) and overlap tab that allows the pipe-boot to be opened and wrapped around a round pipe with an obstruction that prevents the use of a standard pre-molded pipe boot.

Revision Date: July 2019



TYPICAL PHYSICAL PROPERTIES

Typical Properties and Characteristics*	
Standard Sizes	1" (25.4 mm)
	2" (50.8 mm)
	3" (76.2 mm)
	4" (101.6mm)
	5" (127 mm)
	6" (152.4 mm)
Height	8" (203 mm)
Thickness	60 mil TPO membrane
Packaging	8 per carton
Standard Colors	White, Gray and Tan
Colorway Colors	Medium Bronze, Patina Green, Rock Brown, Slate Gray and Terra Cotta

BENEFITS & SUPPLEMENTAL STATEMENTS

- Offers substantial labor savings compared to field fabricated flashings
- Reliable method of waterproofing pipe penetrations
- Simplifies the field installers job when flashing a pipe next to an obstruction
- Provides a more consistent professional appearance compared to field fabricated flashings

INSTALLATION INSTRUCTIONS

1. Clean the penetration to eliminate any rust or scale and wipe with a clean rag saturated with Weathered Membrane Cleaner.
2. Confirm the outside diameter of the pipe. The nominal diameter of the Split Pipe Boot indicates the maximum size the part will effectively fit. Each Split Pipe Boot can accommodate a pipe that is 1-inch smaller in outside diameter. For example, a 2-inch Split Pipe Boot can be utilized to flash pipes ranging from 1-1/6" in diameter up to 2" in diameter.
3. Wrap the Split Pipe Boot around the pipe until the vertical leg is tight against the outside diameter of the pipe penetration.
4. Mark the pipe around the top of the Split Pipe Boot.
5. Remove the Split Pipe Boot from around the pipe.
6. Install Water Cut-Off Mastic below the mark indicating the top of the installed Split Pipe Boot.
7. Wrap the Split Pipe Boot back around the penetration until the vertical leg is tight against the outside diameter of the pipe penetration.
8. Tack weld the back edge of the Split Pipe Boot vertical leg while maintaining good contact between the Split Pipe Boot and the pipe. This process will hold the Split Pipe Boot in place.

TPO SPLIT PIPE BOOT

INSTALLATION INSTRUCTIONS (continued)

9. Heat-weld the entire width of the vertical overlap. Hand roll against the outer surface of the pipe to create the pressure necessary to achieve an acceptable weld.
10. Heat-weld the base flange to the deck membrane and complete the horizontal overlap weld.
11. Once the flashing has completely cooled, check all splices for voids and cold welds. Make any needed repairs.
12. Install a stainless steel universal clamping ring to provide constant compression of the sealant.
13. Apply cut edge sealant to all edges of the Split Pipe Boot that are located on the horizontal plane. Do not apply the sealant to vertical surfaces.

Refer to Mule-Hide specifications and details for additional information

PRECAUTIONS

1. Remove all lead and other flashings.
2. Temperature of project must not exceed 160°F.
3. For mechanically attached membranes, install four seam plates and fasteners around projections. The flange size of the Split Pipe Boot is designed to allow four seam plates and fasteners to fit around the penetration plus a minimum 1 ½" wide weld beyond the outside edge of the seam plates. All plates must fit under the Split Pipe Boot.

STORAGE & HANDLING

Store in a cool, shaded area and cover with light-colored, breathable, waterproof tarps. TPO Split Pipe Boots or TPO membranes that have been exposed to the weather must be prepared with Weathered Membrane Cleaner prior to hot air welding.

PROTECTION & SAFETY

Mule-Hide maintains Safety Data Sheets on all of its non-exempt products. Safety Data Sheets contain health and safety information for your development of appropriate product handling procedures to protect your employees and customers. Mule-Hide Safety Data Sheets should be read and understood by all of your supervisory personnel and employees before using Mule-Hide products in your facilities.

ADDITIONAL INFORMATION

The information given on this PDS is subject to change without notice. Always check the Mule-Hide website at www.mulehide.com for the latest information, changes and updates or contact Mule-Hide Products Company at 800-786-1492.

DISCLAIMER

The statements provided concerning the material shown are intended as a guide for material usage and are believed to be true and accurate at the time of printing. No statement made by anyone may supersede this information, except when done in writing by Mule-Hide Products Co., Inc. Since the manner of use is beyond our control, Mule-Hide does not authorize anyone to make any warranty of merchantability or fitness for any particular purpose or any other warranty, guarantee or representation, expressed or implied, concerning this material. Buyer and user accept the product under these conditions and assume the risk of any failure, any injury person or property (including that of the user), loss or liability resulting from the handling, storage or use of the product whether or not it is handled, stored or used in accordance with the directions or specifications. Mule-Hide must be notified in writing of any claims and be given the opportunity to inspect the alleged failure before repairs are made.



Poly ISO 2

Roof Insulation

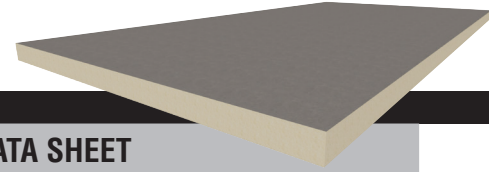

PRODUCT DATA SHEET

DESCRIPTION

MuleHide Poly ISO 2 (flat) and Poly ISO 2 (Tapered) insulations consist of a closed-cell polyisocyanurate foam core laminated to heavy, (non-asphaltic) glass fiber reinforced felt facers. Poly ISO 2 insulations are compatible with all MuleHide membranes and accessories and are available in 20 and 25 psi densities.

BASIC USES

MuleHide Poly ISO 2 insulation boards may be used for ballasted, mechanically attached and fully adhered single-ply roofing systems. Poly ISO 2 insulation boards may be installed over approved decks and substrates on new construction, tear-offs, and recover (retrofit) projects. Rated for use in UL Class A and FM Class 1 assemblies.

BENEFITS & SUPPLEMENTAL STATEMENTS

- Approved for direct application to steel decks
- MuleHide Poly ISO 2™ is manufactured using CFC-, HCFC-, and HFC-free foam blowing technology with zero ozone depletion potential (ODP) and virtually no (negligible) global warming potential (GWP)
- Available as 4' x 4' or 4' x 8' panels in Grade 2 (20 psi) or Grade 3 (25 psi)
- Thicknesses range from 1" to 4.5"
- Contains between 52.9% and 27.6% recycled materials by weight

PACKAGING

Factory-applied packaging is only intended for protection during transit. When stored outside or at the job site, the insulation must be stored at least 4" above ground level and completely covered with a weatherproof covering such as a tarpaulin. **Warning - Do Not Leave Exposed:** This product will burn if exposed to an ignition source of sufficient heat and intensity, or an open flame.

CODE APPROVALS/COMPLIANCE

Poly ISO 2 complies with the requirements of the following specifications, test and code requirements when properly installed.

- ASTM C 1289, Type II, Class 1, Grade 2 (20 psi) or Grade 3 (25 psi)
- CAN/ULC-S704 Type 2, Class 3 or Type 3, Class 3 CCMC No. 12464-L
- FM Standard 4450/4470 Approval, Class 1
- UL Standard 1256 Classification
- UL Standard 790 Classification
- UL Standard 263 Fire Resistance Classification
- UL Standard 1897 Uplift Resistance
- IBC Chapter 26 and NBC Sections on Foam Insulation

(continued page 2)

TYPICAL PHYSICAL PROPERTIES (FLAT & TAPERED)

Property	Test Method	Typical Result
Dimensional Stability	ASTM D2126	<2% Linear Change
Compressive Strength	ASTM D1621 (10% deformation)	20 PSI (Grade 2) 25 PSI (Grade 3)
Water Absorption	ASTM C209, ASTM D2842	< 1.5%, <3.5%
Water Vapor Transmission	ASTM E96	< 1.5 Perm
Product Density	ASTM D1622	Nominal 2 lbs./cubic ft.
Flame Spread (Foam Core)	ASTM E84	40 to 60*
Smoke Development	ASTM E84	50 to 170*
Service Temperature	--	-100°F to 250°F Max**
Tensile Strength	ASTM D1623	>730 psf (35 kPa)

*The numerical ratings are determined by ASTM Test Method E-84 are not intended to reflect hazards presented by this or any other material under actual fire conditions. A flame spread index of 75 or less and smoke development of 450 or less meet code requirements regarding flame spread and smoke development for foam plastic roof insulation. However, the codes exempt foam plastic insulation when used in roof deck constructions that comply as an assembly with FM 4450 or UL 1256 (see IBC, NBC, UBC and SBS Sections on Foam Plastic Insulation (Chapter 26). Smoke development does not apply to roofing.

**ASTM C1289 Standard Specification for Faced Rigid Cellular Polyisocyanurate Thermal Insulation. The physical properties above are presented as typical average values as determined by accepted ASTM test methods and are subject normal manufacturing variation.

POLY ISO 2 (FLAT)

Nominal Thickness*	(mm)	LTR R-Value	RSI	Flute Spanability
1.0	25.4	5.7	1.00	2-5/8
1.5	38.1	8.6	1.51	4-3/8
2.0	50.8	11.4	2.01	4-3/8
2.5	63.5	14.4	2.53	4-3/8
2.6	66	15	2.63	4-3/8
3.0	76.2	17.4	3.06	4-3/8
3.5	88.9	20.5	3.61	4-3/8
4.0	101.6	23.6	4.16	4-3/8

Long Term Thermal Resistance Values are based on ASTM C1289 (revised Jan-2014) and CAN/ULC S770 which provides for a 15-year time-weighted average.

*Other thicknesses available upon special request.

POLY ISO 2 (TAPERED)

Nominal Thickness*	(mm)	LTR R-Value	RSI	Slope Per Ft.
0.5-1.0	12-25	4.3	0.76	1/8"
1.0-1.5	25-38	7.1	1.25	1/8"
1.5-2.0	38-50	10.0	1.76	1/8"
2.0-2.5	50-63	12.9	2.27	1/8"
0.5-1.5	12-38	5.7	1.00	1/4"
1.5-2.5	38-63	11.4	2.01	1/4"
0.5-2.5	12-63	8.6	1.51	1/2"

Long Term Thermal Resistance Values are based on ASTM C1289 (revised Jan-2014) and CAN/ULC S770 which provides for a 15-year time-weighted average.

*Other thicknesses MAY be available upon special request.



Poly ISO 2

Roof Insulation

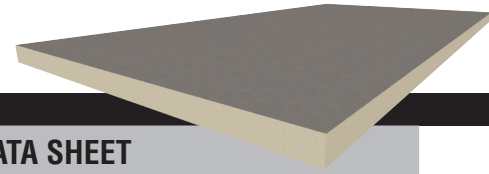

PRODUCT DATA SHEET

PROFILES

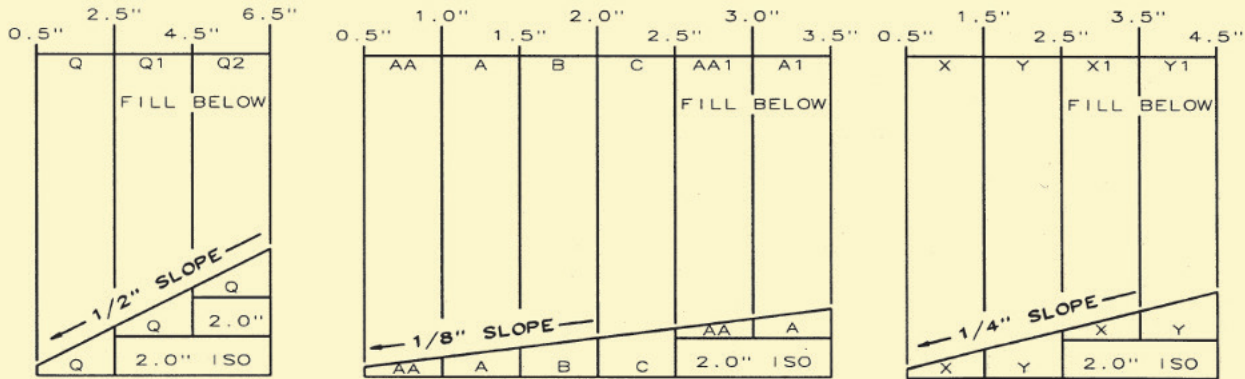

- California State Insulation Quality Standards and Title 25 Foam Flammability Criteria (license #T1231)
- Has achieved GREENGUARD GOLD Certification UL 2818

MuleHide Poly ISO 2 is manufactured using CFC-, HCFC-, and HFC-free foam blowing technology with zero ozone depletion potential (ODP) and virtually no (negligible) global warming potential (GWP).

INSTALLATION INSTRUCTIONS

Ballasted Single-Ply Membrane Systems - MuleHide Poly ISO 2 does not require attachment to the deck in this system. All boards must be tightly fitted together to prevent movement, separation or damage during the installation of the membrane system. All gaps greater than 1/4" must be filled. After the membrane is installed, sufficient amounts of ballast must be applied to prevent membrane and insulation movement. Refer to the MuleHide Manual and FM Loss Prevention Data Sheet 1-29 for information regarding ballasting guidelines.

Mechanically Attached Single-Ply Membrane Systems - MuleHide Poly ISO 2 should be attached with MuleHide fasteners and insulation plates (or FM Approved fasteners) using a minimum of 4 fasteners per 4'x 4' board (1 fastener per 4 square feet) and a minimum of 6 fasteners per 4'x 8' board (1 fastener per 5.33 square feet). Refer to the MuleHide Manual for proper fastener placement.

Fully Adhered Single-Ply Membrane Systems - MuleHide Poly ISO 2 should be installed with the perforated side down. Insulation attachment will vary depending upon insulation thickness and job requirements. If the top layer is less than 2" thick, install a minimum of 8 fasteners per 4'x 4' board (1 fastener per 2 square feet) and a minimum of 16 fasteners per 4'x 8' board (1 fastener per 2 square feet). If the top layer is 2" thick or thicker, install 4 fasteners per 4' x 4' or 8 fasteners per 4' x 8' insulation board. Refer to the MuleHide Manual for proper fastener density and placement. Additional fastening may be required for certain job conditions. In some instances hot, steep asphalt or insulation adhesive may be used

to attach the MuleHide Poly ISO 2 to approved concrete decks. Only 4'x 4' boards may be used. Contact MuleHide's Technical Department for specific requirements and procedures.

PROTECTION & SAFETY

MuleHide maintains safety data sheets on all of its non-exempt products. Safety data sheets contain health and safety information for your development of appropriate product handling procedures to protect your employees and customers. MuleHide's safety data sheets should be read and understood by all of your supervisory personnel and employees before using MuleHide products in your facilities.

ADDITIONAL INFORMATION

On projects where a MuleHide standard or premium warranty is requested, an authorized MuleHide representative shall inspect all completed work.

The information given on this PDS is subject to change without notice. Always check the MuleHide website at www.mulehide.com for the latest information, changes and updates or contact MuleHide at 800-786-1492.

DISCLAIMER

The statements provided concerning the material shown are intended as a guide for material usage and are believed to be true and accurate at the time of printing. No statement made by anyone may supersede this information, except when done in writing by Mule-Hide Products Co., Inc. ("MuleHide"). Since the manner of use is beyond our control, MuleHide does not authorize anyone to make any warranty of merchantability or fitness for any particular purpose or any other warranty, guarantee or representation, expressed or implied, concerning this material. This product may be eligible for a MuleHide warranty, please check the MuleHide website at www.mulehide.com or contact MuleHide directly at 800-786-1492 for details. Buyer and user accept the product under these conditions and assume the risk of any failure, any injury to person or property (including that of the user), loss or liability resulting from the handling, storage or use of the product whether or not it is handled, stored or used in accordance with the directions or specifications. MuleHide must be notified in writing of any claims and be given the opportunity to inspect the alleged failure before repairs are made.



Poly ISO 1

Roof Insulation



PRODUCT DATA SHEET

DESCRIPTION

MuleHide Poly ISO 1 polyisocyanurate insulation (flat or tapered) is a closed-cell polyisocyanurate foam core laminated to (non-asphaltic) glass fiber reinforced felt facers. Featuring glass facer with a light and dark side, allowing the installer to choose which side to install up to control flash-off times in fully adhered applications. MuleHide Poly ISO 1 is compatible with all MuleHide membranes and accessories. Available in 20 psi and 25 psi.

BASIC USES

MuleHide Poly ISO 1 insulation board may be used for ballasted, mechanically attached and fully adhered single-ply roofing systems. Poly ISO 1 insulation board may be installed over approved decks and substrates on new construction, tear-offs, and recover (retrofit) projects. Poly ISO 1 insulation board may be used in UL Class A and FM Class 1 assemblies.

BENEFITS AND SUPPLEMENTAL STATEMENTS

- Approved for direct application to steel decks
- MuleHide Poly ISO 1™ is manufactured with NexGen Chemistry: Contains no CFCs, HCFCs, is Zero ODP, EPA Compliant and has virtually no GWP
- Available as 4' x 4' or 4' x 8' panels in Grade 2 (20 psi) or Grade 3 (25 psi)
- Available in 4' x 12' panels in Grade 2 (20 psi) in the following thickness: 1.5", 1.75", 2.0", 2.2", 2.5", 2.6", 3.0", 3.3" and 3.5"

PACKAGING

Factory-applied packaging is only intended for protection during transit. When stored outside or at the job site, the insulation must be stored at least 4" above ground level and completely covered with a weatherproof covering such as a tarpaulin. **Warning - Do Not Leave Exposed:** This product will burn if exposed to an ignition source of sufficient heat and intensity, or an open flame.

CODE APPROVALS/COMPLIANCE

Poly ISO 1™ complies with the requirements of the following specifications, test and code requirements when properly installed

- Federal Specification HH-I-1972/GEN and HH-I-1972/2, Class 1
- ASTM C 1289 Type II, Class 1, Grade 2 (20 psi), Grade 3 (25 psi)
- FM Standard 4450/4470 Approval, Class 1
- UL Standard 1256 Classification
- UL Standard 790 Classification
- UL Standard 263 Fire Resistance Classification

TYPICAL PHYSICAL PROPERTIES

Property	Test Method	Typical Result
Dimensional Stability	ASTM D2126	2% Linear Change (7 days)
Compressive Strength	ASTM D1621	20 PSI (Grade 2) 25 PSI (Grade 3)
Water Absorption	ASTM D209	< 1% By Volume
Water Vapor Transmission	ASTM E96	< One (1) Perm
Service Temperature	--	-100°F to 250°F Max
Flame Spread (Foam Core)	ASTM E84	< 75*
Smoke Development	ASTM E84	< 450*

The physical properties above are presented as typical average values as determined by accepted ASTM test methods and are subject to change. All information can be confirmed by contacting MuleHide.

*The numerical ratings are determined by ASTM Test Method E-84 are not intended to reflect hazards presented by this or any other material under actual fire conditions. A flame spread index of 75 or less and smoke development of 450 or less meet code requirements regarding flame spread and smoke development for foam plastic roof insulation. However, the codes exempt foam plastic insulation when used in roof deck constructions that comply as an assembly with FM 4450 or UL 1256 (see IBC, NBC, UBC and SBS Sections on Foam Plastic Insulation (Chapter 26). Smoke development does not apply to roofing.

TYPICAL PHYSICAL PROPERTIES (CONTINUED)

Nominal Thickness*	(mm)	LTR R-Value	C-Value	Metal Deck Max. Flute
0.5	13	2.8	.350	2-5/8
1.0	25	5.7	.175	2-5/8
1.5†	38	8.6	.116	4-3/8
1.75†	44	10.0	.100	4-3/8
1.8	46	10.3	.097	4-3/8
2.0†	51	11.4	.088	4-3/8
2.2†	56	12.6	.080	4-3/8
2.5†	64	14.4	.069	4-3/8
2.6†	66	15.0	.067	4-3/8
3.0†	76	17.4	.057	4-3/8
3.3†	84	19.2	.053	4-3/8
3.5†	89	20.5	.049	4-3/8
3.8	97	22.3	.045	4-3/8
4.0	102	23.6	.042	4-3/8
4.3	109	25.5	.039	4-3/8
4.5	114	26.8	.037	4-3/8

Long Term Thermal Resistance Values are based on ASTM C1289 (revised Jan-2014) and CAN/ULC S770 which provides for a 15-year time-weighted average.

*Other thicknesses available upon special request.

†4'x12' panel

LEED INFORMATION

Pre-consumer Recycled Content	5%
Post-consumer Recycled Content	0%
Manufacturing Location	Puyallup, WA; Fanklin Park, IL; Tooele, UT; Smithfield, PA; Montgomery, NY; Terrell, TX; Lake City, FL
Available Sizes	2.0" and 2.6"



Poly ISO 1

Roof Insulation



PRODUCT DATA SHEET

PROFILES

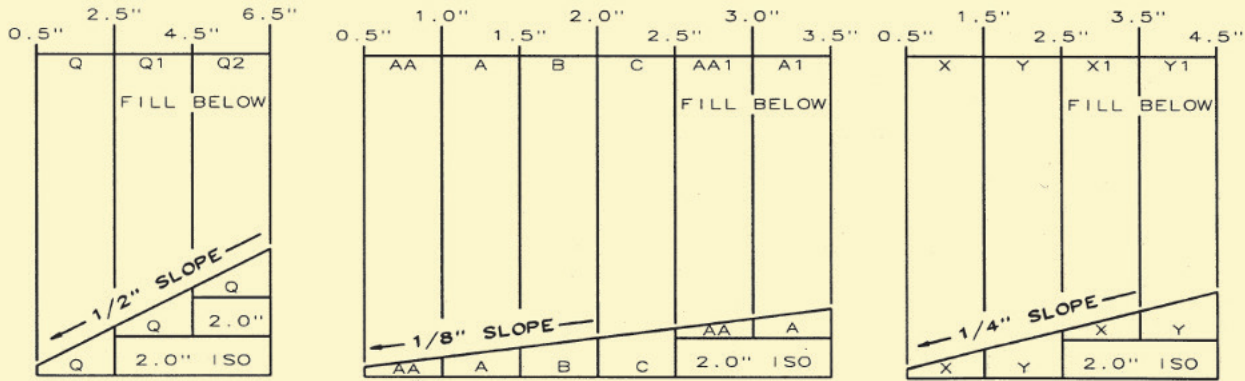

INSTALLATION INSTRUCTIONS

Ballasted Single-Ply Membrane Systems - MuleHide Poly ISO 1 does not require attachment to the deck in this system. All boards must be tightly fitted together to prevent movement, separation or damage during the installation of the membrane system. All gaps greater than 1/4" must be filled. After the membrane is installed, sufficient amounts of ballast must be applied to prevent membrane and insulation movement. Refer to the MuleHide Manual and FM Loss Prevention Data Sheet 1-29 for information regarding ballasting guidelines.

Mechanically Attached Single-Ply Membrane Systems - MuleHide Poly ISO 1 should be attached with MuleHide fasteners and insulation plates (or FM Approved fasteners) using a minimum of 4 fasteners per 4'x 4' board (1 fastener per 4 square feet) and a minimum of 6 fasteners per 4'x 8' board (1 fastener per 5.33 square feet). Refer to the MuleHide Manual for proper fastener placement. When using 4'x12' Poly-Iso 1 boards, 6 fasteners and plates per board may be acceptable on MuleHide system warranties up to 20 years (minimum 1.5" board thickness). Not acceptable on recover/no tear-off projects.

Fully Adhered Single-Ply Membrane Systems - MuleHide Poly ISO 1 should be installed with the perforated side down. Insulation attachment will vary depending upon insulation thickness and job requirements. If the top layer is less than 2" thick, install a minimum of 8 fasteners per 4'x 4' board (1 fastener per 2 square feet) and a minimum of 16 fasteners per 4'x 8' board (1 fastener per 2 square feet). If the top layer is 2" thick or thicker, install 4 fasteners per 4' x 4' or 8 fasteners per 4' x 8' insulation board. Refer to the MuleHide Manual for proper fastener density and placement. Additional fastening may be required for certain job conditions. In some instances hot steep asphalt or insulation adhesive may be used to attach the MuleHide Poly ISO 1 to approved concrete decks. Only 4'x 4' boards may be used. Contact MuleHide's Technical Department for specific requirements and procedures. 4'x12' Polyiso 1 boards shall be fastened at the same or greater rate per square foot of board.

PROTECTION & SAFETY

MuleHide maintains safety data sheets on all of its non-exempt products. Safety data sheets contain health and safety information for your development of appropriate product handling procedures to protect your employees and customers. MuleHide's safety data sheets should be read and understood by all of your supervisory personnel and employees before using MuleHide products in your facilities.

ADDITIONAL INFORMATION

On projects where a MuleHide standard or premium warranty is requested, an authorized MuleHide representative shall inspect all completed work.

The information given on this PDS is subject to change without notice. Always check the MuleHide website at www.mulehide.com for the latest information, changes and updates or contact MuleHide at 800-786-1492.

DISCLAIMER

The statements provided concerning the material shown are intended as a guide for material usage and are believed to be true and accurate at the time of printing. No statement made by anyone may supersede this information, except when done in writing by Mule-Hide Products Co., Inc. ("MuleHide"). Since the manner of use is beyond our control, MuleHide does not authorize anyone to make any warranty of merchantability or fitness for any particular purpose or any other warranty, guarantee or representation, expressed or implied, concerning this material. This product may be eligible for a MuleHide warranty, please check the MuleHide website at www.mulehide.com or contact MuleHide directly at 800-786-1492 for details. Buyer and user accept the product under these conditions and assume the risk of any failure, any injury to person or property (including that of the user), loss or liability resulting from the handling, storage or use of the product whether or not it is handled, stored or used in accordance with the directions or specifications. MuleHide must be notified in writing of any claims and be given the opportunity to inspect the alleged failure before repairs are made.



MULE-HIDE 2.4" SEAM PLATE

PRODUCT DESCRIPTION

Rev. May 2020

Mule-Hide's 2.4" Seam Plates are round Galvalume coated metal plates with (14) barbed anchors and reinforcing ribs for superior wind uplift resistance

BASIC USES

Mule-Hide's 2.4" Seam Plates are designed for the mechanical attachment of the Mule-Hide Reinforced EPDM, PVC and TPO membranes. The 2.4" Seam Plates are attached with Mule-Hide HDP Fasteners or EHD Fasteners. In addition to securing mechanically attached reinforced membranes, our 2.4" Seam Plates can be used with our reinforced 6" wide RMS, or our 6" wide and 10" wide RUSS™ Strips.



SPECIFICATIONS

Material:	20 ga. Galvalume coated metal
Coating:	Galvalume AZ-55 meeting ASTM A 792 Grade 50A
Corrosion:	Meets requirements of FM 4470, ASTM D6294 and DIN 50018
LEED Eligible Recycle Content	49%
Manufacturing Location	Cleveland, OH

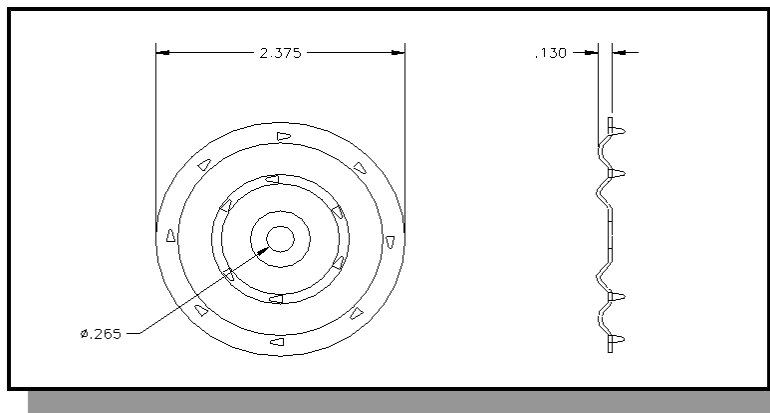

CODE

APPROVALS/COMPLIANCE

Mule-Hide HDP Fasteners comply with the requirements of the following specifications, test and code requirements when properly installed.

* FM Standard 4450/4470 Approval * Metro-Dade Approved *Florida Product Approval

PACKAGING

Packaged in buckets of 1,000, approximate weight is 52# per box.

INSTALLATION INSTRUCTIONS

Install Mule-Hide 2.4" Seam Plates with barbs facing toward membrane (see appropriate detail drawing). Secure 2.4" Seam Plate with Mule-Hide HDP or EHD fasteners in to substrate. Use eye protection when installing fasteners.

MULE-HIDE 2.4" SEAM PLATE

PROTECTION & SAFETY

Mule-Hide maintains Safety Data Sheets on all of its non-exempt products. Safety Data Sheets contain health and safety information for your development of appropriate product handling procedures to protect your employees and customers. Mule-Hide's Safety Data Sheets should be read and understood by all of your supervisory personnel and employees before using Mule-Hide products in your facilities.

ADDITIONAL INFORMATION

The information given on this PDS is subject to change without notice. Always check the Mule-Hide website at www.mulehide.com for the latest information, changes and updates or contact Mule-Hide Products Company at 800-786-1492.

DISCLAIMER

The statements provided concerning the material shown are intended as a guide for material usage and are believed to be true and accurate at the time of printing. No statement made by anyone may supersede this information, except when done in writing by Mule-Hide Products Co., Inc. Since the manner of use is beyond our control, Mule-Hide does not authorize anyone to make any warranty of merchantability or fitness for any particular purpose or any other warranty, guarantee or representation, expressed or implied, concerning this material. This product may be eligible for a Mule-Hide warranty, please check the Mule-Hide website at www.mulehide.com or contact Mule-Hide directly at 800-786-1492 for details. Buyer and user accept the product under these conditions and assume the risk of any failure, any injury person or property (including that of the user), loss or liability resulting from the handling, storage or use of the product whether or not it is handled, stored or used in accordance with the directions or specifications. Mule-Hide must be notified in writing of any claims and be given the opportunity to inspect the alleged failure before repairs are made.



Product Data Sheet

MULE-HIDE PRESSURE SENSITIVE RUSS™ (6")

PRODUCT DESCRIPTION

TPO Pressure-Sensitive RUSS is a nominal 0.045" (1.14mm) thick reinforced TPO membrane strip with a nominal 0.035" (0.89mm) thick, fully cured synthetic rubber pressure sensitive adhesive laminated along one edge. The pressure sensitive adhesive is non-staining and will not affect the color of the membrane over time. The reinforced TPO membrane is 6" (150mm) wide while the adhesive strip is 3" (75mm) wide.



BASIC USES

TPO Pressure-Sensitive RUSS may be used with TPO and White-on-Black EPDM membrane and should only be installed on horizontal surfaces using an appropriate Mule-Hide fastener below the roof membrane to provide additional securement at angle changes. RUSS is secured with Mule-Hide EHD (#15) or HDP (#14) Fasteners and Mule-Hide 2.4" Seam Plates.

TYPICAL PHYSICAL PROPERTIES

Typical Properties and Characteristics*	
Base	Membrane-TPO (Polyester Reinforced) Adhesive-Synthetic Rubber
Thickness	Membrane 0.045" (1.14mm) Adhesive 0.035" (0.89mm)
Size	6" x 100' (150mm x 30.5m)
Packaging	200 lf/ctn (60m) - 2 rolls
Weight/Carton	40 lbs. (18.1 kg)
Shelf Life	1 year

*Typical properties and characteristics are based on samples tested and are not guaranteed for all samples of this product. This data and information is intended as a guide and does not reflect the specification range for any particular property of this product.

BENEFITS

- Eliminates need for separate wall flashing
- Eliminates penetrations thru the sheet at the base of projections or vertical walls
- Eliminates difficult task of heat welded next to a vertical surface

INSTALLATION INSTRUCTIONS

1. Unroll and position TPO 6-Inch Pressure Sensitive RUSS horizontally at the base of a parapet wall or curb. Locate the tab with fastener markings toward the wall and the pre-applied tape toward the field of the roof facing upwards.
2. Position 2.4" Seam Plates 1/8" to 3/4" (3 to 19mm) from the angle change and 12" (300mm) on center maximum and secure with HDP #14) or EHD #15) Fasteners. Do not fasten plates over top of the release liner as this will cause the liner to tear when removed. Mule-Hide recommends that the RUSS be fastened horizontally. In a case where fasteners must be located on the vertical surface, care must be taken to crease the RUSS and the membrane tightly into the angle change to maximize contact between the tape and membrane. Membrane must be adhered to the full width of the tape. Placing the plates tight into the angle change will help hold the RUSS in the proper position.

Product Data Sheet

MULE-HIDE PRESSURE SENSITIVE RUSS™ (6")

INSTALLATION INSTRUCTIONS (Continued)

3. Remove any dirt or dust resulting from plate installation. Any residual dust/dirt will be detrimental to the bond strength of the tape adhesive.
4. Position deck membrane and thoroughly clean the underside of the deck membrane using Weathered Membrane Cleaner if necessary. (The entire surface of the membrane where the tape is to contact must be clean. The TPO 6-Inch Pressure Sensitive RUSS adhesive will not adhere to dusted/dirty surfaces)
5. Apply Tape Primer to the underside of the deck membrane in the area that will come in contact with the 3" wide tape. Refer to Mule-Hide Product Data Sheet for application instructions.
6. Remove the release liner from the adhesive tape on the TPO 6-Inch Pressure Sensitive RUSS pulling it parallel to the roof deck.
7. Roll the deck membrane onto the exposed adhesive tape and apply hand pressure to the splice area.
8. Pull the membrane back to expose the unadhered portion of the TPO 6-Inch Pressure Sensitive RUSS. Apply TPO Bonding Adhesive or Low VOC Bonding Adhesive to the underside of the deck membrane, exposed TPO 6-Inch Pressure Sensitive RUSS and parapet wall.
9. Once the adhesive has dried, roll membrane to the angle change and crease. (Take extra care when creasing TPO membrane into the angle change to achieve desirable appearance). Roll the membrane up the wall and broom for 100% adhesion.
10. Roll the entire 6" (150mm) width of the TPO 6-Inch PS RUSS splice area with a 2" (50mm) wide roller using positive pressure.
11. To achieve proper adhesion of the TPO 6-Inch PS RUSS when job site temperatures fall below 40°F (5°C), heat the cleaned, primed area with a hot air gun as the membrane is applied and pressed into place.

PRECAUTIONS

1. Mule-Hide recommends that the TPO 6" Pressure Sensitive RUSS be installed and fastened into only horizontal surfaces. See "Installation" section for cautions when using this product vertically.
2. Mule-Hide EHD (#15) or HDP (#14) fasteners and Mule-Hide 2.4" Seam Plates must be used when installing the TPO Pressure Sensitive RUSS.
3. Review the applicable Material Safety Data Sheet for complete safety information prior to use.
4. Due to solvent flash-off, condensation may form on freshly applied Tape Primer when the ambient temperature is near the dew point. If condensation develops, the application of primer and installation of TPO Pressure Sensitive RUSS must be discontinued as proper adhesion will not be achieved. Allow the primer surface to dry and apply a thin freshener coat of Tape Primer to the previously coated surface when conditions allow.
5. KEEP OUT OF REACH OF CHILDREN

STORAGE & HANDLING

1. TPO Pressure-Sensitive RUSS must be stored in a dry area.
2. Job site or warehouse storage temperatures in excess of 90°F (32°C) may affect product shelf life.
3. Prolonged job site or warehouse exposure to temperatures below 40°F (4°C) will cause tape adhesive to lose tack and in extreme cases not bond to the membrane. If this situation is encountered, remove TPO Pressure-Sensitive RUSS to a warm area and allow it to return to a minimum of 60°F (15°C).

PROTECTION & SAFETY

Mule-Hide maintains Safety Data Sheets on all of its non-exempt products. Safety Data Sheets contain health and safety information for your development of appropriate product handling procedures to protect your employees and customers. Mule-Hide's Safety Data Sheets should be read and understood by all of your supervisory personnel and employees before using Mule-Hide products in your facilities.

Product Data Sheet

MULE-HIDE PRESSURE SENSITIVE RUSST™ (6")

ADDITIONAL INFORMATION

The information given on this PDS is subject to change without notice. Always check the Mule-Hide website at www.mulehide.com for the latest information, changes and updates or contact Mule-Hide Products Company at 800-786-1492.

DISCLAIMER

The statements provided concerning the material shown are intended as a guide for material usage and are believed to be true and accurate at the time of printing. No statement made by anyone may supersede this information, except when done in writing by Mule-Hide Products Co., Inc. Since the manner of use is beyond our control, Mule-Hide does not authorize anyone to make any warranty of merchantability or fitness for any particular purpose or any other warranty, guarantee or representation, expressed or implied, concerning this material. Buyer and user accept the product under these conditions and assume the risk of any failure, any injury person or property (including that of the user), loss or liability resulting from the handling, storage or use of the product whether or not it is handled, stored or used in accordance with the directions or specifications. Mule-Hide must be notified in writing of any claims and be given the opportunity to inspect the alleged failure before repairs are made.



Product Data Sheet

DensDeck® Prime Roof Board

PRODUCT DESCRIPTION

Revision Date: February 2021

DensDeck Prime Roof Board's patented design features a gypsum core with embedded glass mat facers on the top and bottom of the board. DensDeck Prime can be used in a variety of commercial roof systems and provides an excellent thermal barrier as well as exceptional fire, moisture, and wind uplift resistance properties.

DensDeck Prime is typically used as a cover board over insulation in fully adhered EPDM, TPO, and PVC applications. It is compatible with solvent-based bonding adhesives. For applications in which Helix Max is used to attach insulation and a vapor barrier is specified, DensDeck Prime can be used as a base layer for Mule-Hide's F5 Air and Vapor Barrier (in conjunction with Aeroweb). DensDeck Prime is also compatible with hot asphalt and can be used as a membrane underlayment in hot mopped roofing systems or as a parapet wall substrate in all systems.



TYPICAL PHYSICAL PROPERTIES

Properties	1/4" (6.4 mm)	1/2" (12.7 mm)	5/8" (15.9 mm)
Thickness, nominal	1/4" (6.4 mm) ± 1/16" (1.6 mm)	1/2" (12.7 mm) ± 1/32" (0.8 mm)	5/8" (15.9 mm) ± 1/32" (0.8 mm)
Width, Standard	4' (1219 mm) ± 1/8" (3 mm)	4' (1219 mm) ± 1/8" (3 mm)	4' (1219 mm) ± 1/8" (3 mm)
Length, Standard	4' (1219 mm) 8' (2438 mm) ± 1/4" (6.4 mm)	4' (1219 mm) 8' (2438 mm) ± 1/4" (6.4 mm)	4' (1219 mm) 8' (2438 mm) ± 1/4" (6.4 mm)
Weight, nominal, lbs./sq. ft. (Kg/m ²) ⁷	1.2 (5.9)	2.0 (9.8)	2.5 (12.2)
Surfacing	Fiberglass Mat with non-asphaltic coating	Fiberglass Mat with non-asphaltic coating	Fiberglass Mat with non-asphaltic coating
Flexural Strength ¹ , parallel, lbf. Min. (N)	≥40 (178)	≥80 (356)	≥100 (444)
Flute Spanability ²	2-5/8" (67 mm)	5" (127mm)	8" (203mm)
Permeance ³ , perms (ng/Pa• S• m ²)	>30 (1710)	>23 (1300)	>17 (970)
R Value ⁴ , ft ² • °F• hr/BTU (m ² K/W)	0.28	0.56	0.67
Linear Variation with Change in Temp., in/in °F (mm/mm/°C)	8.5 x 10 ⁻⁶ (15.3 x 10 ⁻⁶)	8.5 x 10 ⁻⁶ (15.3 x 10 ⁻⁶)	8.5 x 10 ⁻⁶ (15.3 x 10 ⁻⁶)
Linear Variation with Change in Moisture	6.25 x 10 ⁻⁶	6.25 x 10 ⁻⁶	6.25 x 10 ⁻⁶
Water Absorption ⁵ , %	5	5	5
Compressive Strength ⁶ , psi nominal	900	900	900
Surface Water Absorption, rams, nominal ¹	1.0	1.0	1.0
Flame Spread, Smoke Developed (ASTM E84)	0/0	0/0	0/0
Bending Radius	4' (1219 mm)	6' (1829 mm)	8' (2438 mm)

¹ Tested in accordance with ASTM C473 method B.

² Tested in accordance with ASTM E661.

³ Tested in accordance with ASTM E96 (dry cup method)

⁴ Tested in accordance with ASTM C518 (heat flow meter).

⁵ Tested in accordance with ASTM C1177.

⁶ Tested in accordance with ASTM C473.

⁷ Represents approximate weight for design and shipping purposes. Actual weight may vary based on manufacturing Location and other factors.

DensDeck[®] Prime Roof Board

BENEFITS AND SUPPLEMENTAL STATEMENTS

- UL code ratings available for (class A, B, C) unlimited slopes and wood decks
- FM Approved
- Improves resistance to foot traffic and hail damage
- Excellent wind uplift ratings
- Resistant to deterioration, warping, and jobsite damage
- 5/8" DensDeck Prime can replace any generic Type "X" gypsum board in any roof assembly in the UL Fire Resistance Directory under the prefix "P"

PACKAGING

Factory applied packaging is only intended for protection during transit.

1/4" 4'x4' Panels	60 pieces	1152 lbs
1/4" 4'x8' Panels	42 pieces	1613 lbs
1/2" 4'x4' Panels	50 pieces	1600 lbs
1/2" 4'x8' Panels	30 pieces	1920 lbs
5/8" 4'x4' Panels	40 pieces	1600 lbs
5/8" 4'x8' Panels	30 pieces	2400 lbs

STORAGE

When stored outside or at the job site, the roof board must be stored at least 4" above ground level and completely covered with a weatherproof covering such as a tarpaulin. **Warning - Do Not Leave Exposed:** Product must be kept dry at all times. Install only as much roof board as can be covered the same day by the roofing system.

CODE APPROVALS/COMPLIANCE

- Manufactured to conform to ASTM C-1177
- Tested in accordance with ASTM E-84 or CAN/ULC-S102
- Non-combustible when tested in accordance with ASTM E-136
- UL code approval for current class A, B, C approvals UL Class A

INSTALLATION INSTRUCTIONS

DensDeck Prime may be secured with Helix Max Adhesive, fastened in accordance with an approved fastening pattern, or mopped with Type III or IV asphalt.

Maximum asphalt application temperatures of 425°F (218°C) to 450°F (232°C) are recommended. Application temperatures above these recommended temperatures may adversely affect roof system performance.

Edge joints should be located on and parallel to deck ribs. End joints of adjacent lengths should be staggered.

1. This material shall be installed with ends and edges butted tightly.
2. When installed over combustible wood decks or insulations, all joints should be staggered.
3. In accordance with approved shop drawings, FM Approved fasteners shall be installed with plates through the roof board, flush with the surface.

Review Mule-Hide specifications and details for complete installation information.

PRECAUTIONS

- When applying solvent-based adhesives or primers, allow sufficient time for the solvents to flash off.
- 1/4" DensDeck is not recommended for vertical parapet applications or for asphalt attachment.
- In ballasted roofing systems, DensDeck is not an acceptable membrane underlayment.

DensDeck® Prime Roof Board

LEED INFORMATION

Manufacturing Location ¹	Total Recycled Content ²	Pre-Consumer Recycled Content ²	Post-Consumer Recycled Content ²
Acme, TX	0%	0%	0%
Antioch, CA	0%	0%	0%
Ft. Dodge, IA	0%	0%	0%
Las Vegas, NV	0%	0%	0%
Lovell, WY	0%	0%	0%
Newington, NH	30%	30%	0%
Savannah, GA	0%	0%	0%
Tacoma, WA	14%	14%	0%
Wheatfield, IN	94%	94%	0%

¹ Manufacturing locations subject to change. Please visit www.gpgypsum.com and click on Sustainability.

² Recycled content subject to change + / - 1.0%.

³ Based on ICC Evaluation Service Verification of Attributes Report for Dens® brand products issued August 1, 2009. www.saveprogram.icc-es.org

PROTECTION & SAFETY

Mule-Hide maintains Safety Data Sheets on all of its non-exempt products. Safety Data Sheets contain health and safety information for your development of appropriate product handling procedures to protect your employees and customers. Mule-Hide's Safety Data Sheets should be read and understood by all of your supervisory personnel and employees before using Mule-Hide products in your facilities.

ADDITIONAL INFORMATION

The information given on this PDS is subject to change without notice. Always check the Mule-Hide website at www.mulehide.com for the latest information, changes and updates or contact Mule-Hide Products Company at 800-786-1492.

DensDeck is a registered trademark of Georgia-Pacific Gypsum LLC.

DISCLAIMER

The statements provided concerning the material shown are intended as a guide for material usage and are believed to be true and accurate at the time of printing. No statement made by anyone may supersede this information, except when done in writing by Mule-Hide Products Co., Inc. Since the manner of use is beyond our control, Mule-Hide does not authorize anyone to make any warranty of merchantability or fitness for any particular purpose or any other warranty, guarantee or representation, expressed or implied, concerning this material. This product may be eligible for a Mule-Hide warranty, please check the Mule-Hide website at www.mulehide.com or contact Mule-Hide directly at 800-786-1492 for details. Buyer and user accept the product under these conditions and assume the risk of any failure, any injury person or property (including that of the user), loss or liability resulting from the handling, storage or use of the product whether or not it is handled, stored or used in accordance with the directions or specifications. Mule-Hide must be notified in writing of any claims and be given the opportunity to inspect the alleged failure before repairs are made.



USG SECUROCK® Gypsum-Fiber Roof Board

PRODUCT DESCRIPTION

USG SECUROCK Gypsum-Fiber Roof Board is a high-performance roof board for use in low-slope roofing systems. Its unique, fiber-reinforced, homogenous composition means the panel is strong and water-resistant all the way through to its core. USG SECUROCK Gypsum-Fiber Roof Board provides low absorption and an exceptional bond in adhered systems, and, because of its homogenous composition, achieves high wind uplift ratings with no risk of facer delamination. Made from 97% recycled material, USG SECUROCK Gypsum-Fiber Roof Board combines superior performance with sustainable design for single-ply roofing systems.

Revision Date: February 2021



TYPICAL PROPERTIES AND CHARACTERISTICS

Properties	1/4" (6.6 mm)	3/8" (19.5 mm)	1/2" (12.7 mm)	5/8" (15.9 mm)
Thickness, nominal	1/4" (6.4 mm) ± 1/16" (1.6 mm)	3/8" (19.5 mm) ± 1/16" (1.6 mm)	1/2" (12.7 mm) ± 1/32" (0.8 mm)	5/8" (15.9 mm) ± 1/32" (0.8 mm)
Width, Standard	4' (1220 mm)	4' (1220 mm)	4' (1220 mm)	4' (1220 mm)
Length, Standard	4' (1220 mm) and 8' (2438 mm)	4' (1220 mm) and 8' (2438 mm)	4' (1220 mm) and 8' (2438 mm)	4' (1220 mm) and 8' (2438 mm)
Weight, nominal, lbs./sq. ft.	1.57	1.96	3.2	3.2
Flexural Strength, parallel, lbf. min. per ASTM C 473	40	70	110	161
Compressive Strength, psi nominal	1800	1800	1800	1800
Flute Spanability per ASTM E 661	2-5/8"	5"	8"	10"
Permeance, perms per ASTM E 96	30	26	26	24
R Value per ASTM C 518	0.2	0.3	0.5	0.6
Coefficient of thermal expansion, inches/ inch • °F, per ASTM E 831	8.0 x 10 ⁻⁶	8.0 x 10 ⁻⁶	8.0 x 10 ⁻⁶	8.0 x 10 ⁻⁶
Linear Variation with Change in Moisture, inches/inch • %RH, per ASTM E 831	8.0 x 10 ⁻⁶	8.0 x 10 ⁻⁶	8.0 x 10 ⁻⁶	8.0 x 10 ⁻⁶
Water Absorption, % max, per ASTM C 473	10	10	10	10
Surface Water Absorption, nominal grams, per ASTM C 473	1.6	1.6	1.6	1.6
Mold Resistance per ASTM D 3273*	10	10	10	10
Bending Radius	25'	25'	25'	25'

Typical properties and characteristics are based on samples tested and are not guaranteed for all samples of this product. This data and information is intended as a guide and does not reflect the specification range for any particular property of this product.

*ASTM D3273 Mold Resistance Testing - In independent lab tests conducted on SECUROCK Gypsum-Fiber roof board and SECUROCK Glass-Mat roof board at the time of manufacture per ASTM D3273 Standard Test Method for Resistance to Growth of Mold on the Surface of Interior Coatings in an Environmental Chamber, both panels scored a 10. The ASTM lab test may not accurately represent the mold performance of building materials in actual use. Given unsuitable project conditions during storage, installation or after completion, any building material can be overwhelmed by mold. To manage the growth of mold, the best and most cost-effective strategy is to protect building products from water exposure during storage and installation and after completion of the building. This can be accomplished by using good design and construction practices.

BENEFITS AND SUPPLEMENTAL STATEMENTS

- Exceptional bond and low absorption in adhered systems
- Resistant to moisture and mold
- Exceptional wind uplift performance
- Manufactured from 97% recycled material
- Provides protection from hail and foot traffic when adhered with insulation adhesive

USG SECUROCK[®] Gypsum-Fiber Roof Board

PACKAGING

Factory applied packaging is only intended for protection during transit.

1/4" 4'x4' Panels	100 pieces	2512 lbs
1/4" 4'x8' Panels	50 pieces	2575 lbs
3/8" 4'x4' Panels	80 pieces	2509 lbs
3/8" 4'x8' Panels	40 pieces	2575 lbs
1/2" 4'x4' Panels	60 pieces	2650 lbs
1/2" 4'x8' Panels	30 pieces	2725 lbs
5/8" 4'x4' Panels	48 pieces	2458 lbs
5/8" 4'x8' Panels	24 pieces	2525 lbs

STORAGE

When stored outside or at the job site, the roof board must be stored at least 4" above ground level and completely covered with a weatherproof covering such as a tarpaulin. **Warning - Do Not Leave Exposed:** Product must be kept dry at all times. Install only as much roof board as can be covered the same day by the roofing system.

CODE APPROVALS/COMPLIANCE

- Surface Burning Characteristics and Non-Combustibility in accordance with ASTM E84 (CAN/ULC-S102).
- 1/2" and 5/8" thickness – UL Class A in accordance with UL790 (CAN/ULC-S107) (ASTM E108). See the UL Building Materials Directory for more information.
- 5/8" thickness – Meets requirements of Type X per ASTM C1278 and may be used in ULP series designs as a thermal barrier.
- Meets FM Class 1 (FM 4450 and FM 4470).
- Manufactured to conform to ASTM C1278, "Standard Specification for Fiber-Reinforced Gypsum Panel."

INSTALLATION INSTRUCTIONS

1. All board edges should be loosely abutted and never kicked in tight in typical installations. Please refer to the Typical Properties and Characteristics chart on page 1 to calculate the gap needed for your specific project (coefficient of thermal expansion and linear variation with change in moisture).
2. Install approved fasteners with plates into the USG SECUROCK Gypsum-Fiber Roof Board, flush with the surface. Fasteners should be installed in strict compliance with Mule-Hide's specifications and details.
3. Locate edge joints on, and parallel to, deck ribs. Stagger end joints of adjacent lengths of USG SECUROCK Gypsum-Fiber Roof Board.
4. Roof boards should never be installed when they are frozen.
5. See properties table for maximum flute span when panels are applied directly over metal decking.
6. For vertical parapet applications, only 1/2" or 5/8" panels should be used. Maximum framing spacing is 24" OC.
7. Panel spacing may be needed based on factors like roof deck's size, membrane color, ultimate deck surface temperature and time of year the roof is installed.

Review Mule-Hide specifications and details for complete installation information.

PRECAUTIONS

- Consult Mule-Hide for specific instructions regarding the application of its products to USG SECUROCK Gypsum-Fiber Roof Board.
- For re-roof or re-cover applications, the existing roofing system must be dry throughout prior to application of USG SECUROCK Gypsum-Fiber Roof Board.
- When applying solvent-based adhesives or primers, allow sufficient time for the solvent to evaporate to avoid damage to roofing components.

USG SECUROCK[®] Gypsum-Fiber Roof Board

LEED INFORMATION

Manufacturing Location	Pre-Consumer Recycled Content	Post-Consumer Recycled Content
Aliquippa, PA	97%	0%
Baltimore, MD	97%	0%
Bridgeport, AL	97%	0%
East Chicago, IL	97%	0%
Galena Park, TX	97%	0%
Jacksonville, FL	97%	0%
Norfolk, VA	97%	0%
Plaster City, CA	97%	0%
Rainier, OR	97%	0%
Shoals, IN	97%	0%
Sigurd, UT	97%	0%
Southard, OK	97%	0%
Sperry, IA	97%	0%
Sweetwater, TX	97%	0%
Washingtonville, PA	97%	0%

PROTECTION & SAFETY

Mule-Hide maintains Safety Data Sheets on all of its non-exempt products. Safety Data Sheets contain health and safety information for your development of appropriate product handling procedures to protect your employees and customers. Mule-Hide's Safety Data Sheets should be read and understood by all of your supervisory personnel and employees before using Mule-Hide products in your facilities.

ADDITIONAL INFORMATION

The information given on this PDS is subject to change without notice. Always check the Mule-Hide website at www.mulehide.com for the latest information, changes and updates or contact Mule-Hide Products Company at 800-786-1492.

The trademarks SECUROCK[®], the USG Logo[™] and related marks are trademarks of USG Corporation or its subsidiaries or affiliates.

DISCLAIMER

The statements provided concerning the material shown are intended as a guide for material usage and are believed to be true and accurate at the time of printing. No statement made by anyone may supersede this information, except when done in writing by Mule-Hide Products Co., Inc. Since the manner of use is beyond our control, Mule-Hide does not authorize anyone to make any warranty of merchantability or fitness for any particular purpose or any other warranty, guarantee or representation, expressed or implied, concerning this material. This product may be eligible for a Mule-Hide warranty, please check the Mule-Hide website at www.mulehide.com or contact Mule-Hide directly at 800-786-1492 for details. Buyer and user accept the product under these conditions and assume the risk of any failure, any injury person or property (including that of the user), loss or liability resulting from the handling, storage or use of the product whether or not it is handled, stored or used in accordance with the directions or specifications. Mule-Hide must be notified in writing of any claims and be given the opportunity to inspect the alleged failure before repairs are made.



Product Data Sheet

WEATHERED MEMBRANE CLEANER

PRODUCT DESCRIPTION

Weathered Membrane Cleaner is a clear liquid solvent used to clean EPDM and TPO membranes.

BASIC USES

Weathered Membrane Cleaner is used to clean both new and in-service EPDM and TPO membranes prior to the seaming process. This cleaner helps to loosen and remove dirt and other contaminants from the surface of the EPDM and TPO-c membranes and leaves a suitable surface for welding or the subsequent application of Tape Primer. **Not for use on PVC membranes.**



TYPICAL PHYSICAL PROPERTIES

Typical Properties and Characteristics	
Color	Clear
Solids	0%
Flash Point	65°F (18°C)
Boiling Point	260°F (127°C)
Packaging	5-gallon (18.9 liter) closed top pail Cartons of 2 x 1-gallon (3.8 liter) closed top pail

Typical properties and characteristics are based on samples tested and are not guaranteed for all samples of this product. This data and information is intended as a guide and does not reflect the specification or specification range for any particular property of this product.

LEED Information	
Pre-consumer recycle content	0%
Post-consumer recycle content	0%
Manufacturing Location	Carlisle, PA
VOC Content*	755 grams/liter
*This product is exempt from VOC regulations.	

BENEFITS & SUPPLEMENTAL STATEMENTS

- Easily removes dirt and other contaminants from EPDM and TPO membranes
- Prepares TPO membranes for welding and application of tapes
- Prepares EPDM membranes for application of primer, adhesives and tapes

COVERAGE RATES

Coverage rate depends on the age of the membrane and amount of dirt/debris on the surface. Coverage is approximately 400 square feet (one surface) per gallon

INSTALLATION INSTRUCTIONS

EPDM

1. Remove as much loose material as possible from the membrane surface where the adhesive or pressure-sensitive product will be applied by brooming or wiping the area with a dry rag. Extreme conditions of accumulated dirt may require a low sudsing detergent and water cleaning (rinse area thoroughly with CLEAN water and allow to dry).
2. Saturate a clean rag with Weathered Membrane Cleaner. SCRUB the area in a circular motion. Continue to clean the area, changing rags frequently, until the surface is a consistent color with no streaking. Additional cleaning is required at factory seams (scrub parallel to the seam). Allow to dry.
3. Apply primer according to product instructions and/or roofing system specification.

Product Data Sheet

WEATHERED MEMBRANE CLEANER

INSTALLATION INSTRUCTIONS (continued)

TPO – New

1. Saturate a clean rag with Weathered Membrane Cleaner.
2. Wipe the area to be cleaned until the membrane is a consistent color with no streaking and allow to dry.
3. Weld the cleaned membrane together with an appropriate hot-air welder.

TPO - Aged

1. Using a Scotch-Brite® pad and Weathered Membrane Cleaner, scrub the area to be welded. (the cleaner will become white with membrane residue during this application step)
2. Clean all residue from the area to be welded using a rag soaked with Weathered Membrane Cleaner. Allow to dry.
3. Weld the cleaned material together using an appropriate hot-air welder.

Review Mule-Hide Specifications and Details for additional information.

PRECAUTIONS

1. Review the applicable Safety Data Sheet for complete safety information prior to use.
2. Weathered Membrane Cleaner is **EXTREMELY FLAMMABLE** -It contains solvents that are dangerous fire and explosion hazards when exposed to heat, flame or sparks. Do not smoke while applying. Do not use in a confined or unventilated area. Vapors are heavier than air and may travel along ground or may be moved by ventilation and ignited by pilot lights, other flames, sparks, heaters, smoking, electrical motors, static discharge, or other ignition sources at locations distant from material handling point and flashback. All containers should be grounded when material is transferred from one container to another. A red caution label is required when shipping. A fire extinguisher should be available. In case of fire, use water spray, foam, dry chemical or carbon dioxide. Do not use a solid stream of water because it can scatter and spread the fire.
3. Care must be taken to prevent fumes from entering the building via air ventilation ducts. Do not place open containers near fresh air-intake units. When possible, shut down or seal off the closest units.
4. Avoid breathing vapors. Keep container closed when not in use. Use with adequate ventilation. If inhaled, remove to fresh air. If not breathing, perform artificial respiration. If breathing is difficult, give oxygen. Call a physician immediately.
5. If swallowed, **DO NOT INDUCE VOMITING**. Call a physician immediately.
6. Avoid contact with skin. Wash hands thoroughly after handling. In case of contact with skin, thoroughly wash affected area with soap and water. Contact physician if irritation persists. **Note:** Permeation resistant gloves (that meet ANSI/ISEA 105-2005) are recommended to be worn when using this product to protect hands from irritating ingredients.
7. Avoid contact with eyes. Safety glasses or goggles are recommended. If splashed in eyes, immediately flush eyes with plenty of clean water for at least 15 minutes. Contact a physician immediately.
8. **KEEP OUT OF REACH OF CHILDREN.**

Product Data Sheet

WEATHERED MEMBRANE CLEANER

PROTECTION & SAFETY

Mule-Hide maintains Safety Data Sheets on all of its non-exempt products. Safety Data Sheets contain health and safety information for your development of appropriate product handling procedures to protect your employees and customers. Mule-Hide's Safety Data Sheets should be read and understood by all of your supervisory personnel and employees before using Mule-Hide products in your facilities.

ADDITIONAL INFORMATION

The information given on this PDS is subject to change without notice. Always check the Mule-Hide website at www.mulehide.com for the latest information, changes and updates or contact Mule-Hide Products Company at 800-786-1492.

DISCLAIMER

The statements provided concerning the material shown are intended as a guide for material usage and are believed to be true and accurate at the time of printing. No statement made by anyone may supersede this information, except when done in writing by Mule-Hide Products Co., Inc. Since the manner of use is beyond our control, Mule-Hide does not authorize anyone to make any warranty of merchantability or fitness for any particular purpose or any other warranty, guarantee or representation, expressed or implied, concerning this material. Buyer and user accept the product under these conditions and assume the risk of any failure, any injury person or property (including that of the user), loss or liability resulting from the handling, storage or use of the product whether or not it is handled, stored or used in accordance with the directions or specifications. Mule-Hide must be notified in writing of any claims and be given the opportunity to inspect the alleged failure before repairs are made.



Product Data Sheet

UNIVERSAL SINGLE-PLY SEALANT

PRODUCT DESCRIPTION

A 100% solids, solvent free, one-part, polyether sealant that provides a weather tight seal to a variety of building substrates. Provides excellent adhesive to substrates such as stone, masonry, ceramic, marble, wood, steel, aluminum, most plastics and composites. Not recommended as a glass-glazing sealant.

BASIC USES

Universal Single-Ply Sealant can be used as a:

- Lap-sealant for White-on-Black EPDM roofing systems
- Sealant for All-Purpose Bar on EPDM, TPO, and PVC systems
- Sealant for counter flashings, copings, and scupper details



TYPICAL PHYSICAL PROPERTIES

Typical Properties and Characteristics*	
Viscosity	850,000 Cps
Tack Free Time	25 minutes depending upon temperature
Cure Time	3-7 days depending upon temperature
Flow, Sag or Sump	None (1/4" bead)
Staining	None
Ozone Resistance	Good
UV Resistance	Excellent
Cured Hardness (Shore A)	17 - 23
Shear Strength	150 PSI
Color	White
*Typical properties and characteristics are based on samples tested and are not guaranteed for all samples of this product. This data and information is intended as a guide and does not reflect the specification or specification range for any particular property of this product.	

LEED Information	
Pre-consumer Recycled Content	0%
Post-consumer Recycled Content	0%
Manufacturing Location	Schoolcraft, MI
Solar Reflectance Index (SRI)	N/A

PACKAGING

Packaging	
Weight per Carton	25 lbs
Packaging	25 tubes, 10.1 fluid oz. each (per carton)
Shelf Life	12 months (unopened tube @ 90° F)

BENEFITS & SUPPLEMENTAL STATEMENTS

Excellent adhesion to various substrates
 VOC free
 Versatile applications

COVERAGE RATES

25 feet (7.6 m) per tube or 600 feet (183 m) per carton using a 1/4" (6 mm) bead

Product Data Sheet

UNIVERSAL SINGLE-PLY SEALANT

INSTALLATION TEMPERATURE

Do not install in temperatures below 40° F

INSTALLATION INSTRUCTIONS

1. Universal Single-Ply Sealant is a one-component, ready-to-use material that requires no mixing or preparation.
2. Surface Preparation - Surfaces shall be dry, clean and free of all dust, or contamination, which may harmfully affect the adhesion of the sealant. Cleaning with appropriate membrane cleaner may be required.
 - a. Weathered Membrane Cleaner – EPDM and TPO
 - b. PVC Membrane Cleaner - PVC
3. A quality caulking gun should be used to ensure ease of application.
4. Universal Single-Ply Sealant typically is tack free in 25 minutes and skins over within 45 minutes. Full cure occurs in 3 to 7 days depending on temperature and humidity.
5. Clean Up - Remove excess sealant adjacent to joint prior to curing with our Weathered Membrane Cleaner or PVC Membrane Cleaner. Uncured sealant can also be removed from tools or equipment with our Weathered Membrane Cleaner or PVC Membrane Cleaner.

PRECAUTIONS

1. Avoid prolonged contact with skin. Uncured adhesive irritates eyes. In case of contact with eyes, immediately flush with water. Consult a physician if ill effects occur.
2. Store in original unopened containers in a cool, dry area. Protect unopened containers from heat and direct sunlight. Elevated temperatures will reduce shelf life.
3. KEEP OUT OF THE REACH OF CHILDREN.
4. For industrial professional use only. May not be repackaged or resold for other than industrial or professional use.
5. See Material Safety Data Sheet for complete safety information before using product.
6. Do not use Universal Single-Ply Sealant in temperatures below 40 degrees F.

PROTECTION & SAFETY

Mule-Hide maintains Safety Data Sheets on all of its non-exempt products. Safety Data Sheets contain health and safety information for your development of appropriate product handling procedures to protect your employees and customers. Mule-Hide's Safety Data Sheets should be read and understood by all of your supervisory personnel and employees before using Mule-Hide products in your facilities.

ADDITIONAL INFORMATION

The information given on this PDS is subject to change without notice. Always check the Mule-Hide website at www.mulehide.com for the latest information, changes and updates or contact Mule-Hide Products Company at 800-786-1492.

DISCLAIMER

The statements provided concerning the material shown are intended as a guide for material usage and are believed to be true and accurate at the time of printing. No statement made by anyone may supersede this information, except when done in writing by Mule-Hide Products Co., Inc. Since the manner of use is beyond our control, Mule-Hide does not authorize anyone to make any warranty of merchantability or fitness for any particular purpose or any other warranty, guarantee or representation, expressed or implied, concerning this material. Buyer and user accept the product under these conditions and assume the risk of any failure, any injury person or property (including that of the user), loss or liability resulting from the handling, storage or use of the product whether or not it is handled, stored or used in accordance with the directions or specifications. Mule-Hide must be notified in writing of any claims and be given the opportunity to inspect the alleged failure before repairs are made.



Product Data Sheet

MULE-HIDE ALL PURPOSE BAR

PRODUCT DESCRIPTION

Rev. May 2020

All Purpose Bar is a specially extruded aluminum bar without sharp edges.

BASIC USES

All Purpose Bar is designed for use as an anchor bar for attachment of the Mule-Hide EPDM membranes. The All Purpose Bar may be installed in the field seam as a batten bar and used at the base of curbs, parapet walls and angle changes as an anchor bar. The All Purpose Bar may also be used with any of the Mule-Hide single-ply membranes as a termination bar. Refer to the Mule-Hide Single-Ply Manuals for specific use and installation instructions.

SPECIFICATIONS

Material:	Extruded Aluminum
Dimensions:	.050" thick x 1" wide x 10' long per piece.
Holes:	1/4" x 3/8" slotted holes on 6 inch centers.
Packaged:	50 pieces per tube
Approx. shipping weight:	40 lbs per tube
LEED Eligible Recycled Content	49%
Manufacturing Location	Cleveland, OH



INSTALLATION INSTRUCTIONS

Position All Purpose Bar as per detail drawings (ribs facing outward or ribs facing inward)

When used as edge termination, ensure that water block sealant has been installed as per appropriate detail drawing, position bar with ribs facing substrate (to form sealant pocket) and attach with appropriate fastener into the substrate. When used for base attachment (see appropriate detail) position All Purpose Bar with ribs facing outward and attach with appropriate fastener into substrate.

PROTECTION & SAFETY

Mule-Hide maintains Safety Data Sheets on all of its non-exempt products. Safety Data Sheets contain health and safety information for your development of appropriate product handling procedures to protect your employees and customers. Mule-Hide's Safety Data Sheets should be read and understood by all of your supervisory personnel and employees before using Mule-Hide products in your facilities.

ADDITIONAL INFORMATION

The information given on this PDS is subject to change without notice. Always check the Mule-Hide website at www.mulehide.com for the latest information & updates or contact Mule-Hide Products Company at 800-786-1492.

DISCLAIMER

The statements provided concerning the material shown are intended as a guide for material usage and are believed to be true and accurate at the time of printing. No statement made by anyone may supersede this information, except when done in writing by Mule-Hide Products Co., Inc. Since the manner of use is beyond our control, Mule-Hide does not authorize anyone to make any warranty of merchantability or fitness for any particular purpose or any other warranty, guarantee or representation, expressed or implied, concerning this material. This product may be eligible for a Mule-Hide warranty, please check the Mule-Hide website at www.mulehide.com or contact Mule-Hide directly at 800-786-1492 for details. Buyer and user accept the product under these conditions and assume the risk of any failure, any injury person or property (including that of the user), loss or liability resulting from the handling, storage or use of the product whether or not it is handled, stored or used in accordance with the directions or specifications. Mule-Hide must be notified in writing of any claims and be given the opportunity to inspect the alleged failure before repairs are made.



Water Cut-Off Mastic

Compression Sealant



PRODUCT DATA SHEET



DESCRIPTION

Water Cut-Off Mastic is a one-part, low-viscosity, self-wetting, butyl-blend mastic designed for sealing MuleHide membranes to wood, concrete, metal, plastic and other substrates. This product is an extremely tacky material and will remain so when used with a compression-type seal.

BASIC USES

Water Cut-Off Mastic can be used to seal roofing membranes to stop water penetration into the roofing system. Common uses are at drain terminations and behind MuleHide's All Purpose Bars at wall terminations.

BENEFITS AND SUPPLEMENTAL STATEMENTS

- Excellent adhesion to various substrates
- Provides a durable compression-type seal
- Versatile applications

TYPICAL PROPERTIES AND CHARACTERISTICS*	
Color	Gray
Solids	80%
Flash Point	40°F (4°C) Closed Cup
Service Temperature	-40°F to 200°F (-40°C to 93°C)
Specific Gravity	1.29
Cold-Weather Flexibility	Excellent
Average Brookfield Viscosity	1,320,000 cps

*Typical properties and characteristics are based on samples tested and are not guaranteed for all samples of this product. This data and information is intended as a guide and does not reflect the specification or specification range for any particular property of this product.

LEED INFORMATION	
Pre-consumer Recycled Content	0%
Post-consumer Recycled Content	0%
Manufacturing Location	Carlisle, PA
VOC Content	250 g/L

PACKAGING

- (25) 11-oz tubes/carton. Weight per carton, 28 lbs.

COVERAGE RATES

- Approximately 10 lineal feet per using a ½" diameter bead.

SHELF LIFE

- 1 year (un opened tube).

INSTALLATION INSTRUCTIONS

1. MuleHide Water Cut-Off Mastic is a one-component, ready-to-use material that requires no mixing or preparation.
2. Surface Preparation - Surfaces shall be dry, clean and free of all dust, or contamination, which may harmfully affect the adhesion of the sealant. Cleaning with appropriate cleaner, Weathered Membrane Cleaner (or PVC Membrane Cleaner may be required).
 - a. Weathered Membrane Cleaner for EPDM and TPO
 - b. PVC Membrane Cleaner for PVC
3. A quality caulking gun should be used to ensure ease of application.
4. Apply a ½" diameter bead of MuleHide Water Cut-Off Mastic between the substrate and the edge of the membrane. The membrane must cover the mastic.
5. Install appropriate termination detail and secure to provide constant compression for the MuleHide Water Cut-Off Mastic. Follow MuleHide's Specification Manual and Details for appropriate methods of termination.

CLEAN UP

- Clean Up - Excess Water Cut-Off Mastic can be removed with our Weathered Membrane Cleaner or PVC Membrane Cleaner. Water Cut-Off Mastic can also be removed from tools or equipment with our Weathered Membrane Cleaner or PVC Membrane Cleaner.



Water Cut-Off Mastic

Compression Sealant



PRODUCT DATA SHEET

PRECAUTIONS

- See Material Safety Data Sheet for complete safety information before using product.
- Water Cut-Off Mastic is **FLAMMABLE** – contains solvents that are dangerous fire and explosion hazards when exposed to heat, flame or sparks. Store and use away from all sources of heat, flame or sparks. Do not smoke while applying. Do not use in a confined or unventilated area. Vapors are heavier than air and may travel along ground to a distant ignition source and flash back
- Avoid breathing vapors. Keep container closed when not in use. Use with adequate ventilation. If inhaled, remove to fresh air. If not breathing, perform artificial respiration. If breathing is difficult, give oxygen. Call a physician immediately.
- If swallowed, **DO NOT INDUCE VOMITING**. Call a physician immediately.
- Avoid contact with eyes. Safety glasses or goggles are recommended. If splashed in eyes, immediately flush eyes with plenty of clean water for at least 15 minutes. Contact a physician immediately.
- Avoid contact with skin. Wash hands thoroughly after handling. In case of contact with skin, thoroughly wash affected area with soap and water.

Note: Permeation-resistant gloves (that meet ANSI/ISEA 105-2005) are recommended to be worn when using this product to protect hands from irritating ingredients.

PROTECTION & SAFETY

MuleHide maintains safety data sheets on all of its non-exempt products. Safety data sheets contain health and safety information for your development of appropriate product handling procedures to protect your employees and customers. MuleHide's safety data sheets should be read and understood by all of your supervisory personnel and employees before using MuleHide products in your facilities.

ADDITIONAL INFORMATION

On projects where a MuleHide standard or premium warranty is requested, an authorized MuleHide representative shall inspect all completed work.

The information given on this PDS is subject to change without notice. Always check the MuleHide website at www.mulehide.com for the latest information, changes and updates or contact MuleHide at 800-786-1492.

DISCLAIMER

The statements provided concerning the material shown are intended as a guide for material usage and are believed to be true and accurate at the time of printing. No statement made by anyone may supersede this information, except when done in writing by Mule-Hide Products Co., Inc. ("MuleHide"). Since the manner of use is beyond our control, MuleHide does not authorize anyone to make any warranty of merchantability or fitness for any particular purpose or any other warranty, guarantee or representation, expressed or implied, concerning this material. This product may be eligible for a MuleHide warranty, please check the MuleHide website at www.mulehide.com or contact MuleHide directly at 800-786-1492 for details. Buyer and user accept the product under these conditions and assume the risk of any failure, any injury to person or property (including that of the user), loss or liability resulting from the handling, storage or use of the product whether or not it is handled, stored or used in accordance with the directions or specifications. MuleHide must be notified in writing of any claims and be given the opportunity to inspect the alleged failure before repairs are made.



Product Data Sheet

MULE-HIDE TPO CUT-EDGE SEALANT

PRODUCT DESCRIPTION

Mule-Hide TPO Cut-Edge Sealant is a thermoplastic compound designed for use at the edge of cut Mule-Hide TPO-c membrane seams after the membrane has been welded to itself or to Mule-Hide TPO Coated Metal.

BASIC USES

Mule-Hide TPO Cut-Edge Sealant is required to seal all cut edges of TPO membrane (seams and flashing) where the reinforcing scrim is exposed to weather.

TYPICAL PHYSICAL PROPERTIES

Typical Properties and Characteristics*	
Base	Synthetic Rubber
Color	Clear
Solids	14%
Viscosity	3,500 cps
Flash Point	39°F (4°C)
Resistance to:	
- Ozone	Excellent
-UV	Excellent
-Water	Excellent
Net Weight / Gallon	7.4 lbs (3.3 Kg)
Packaging	8 – 16 oz bottles per carton (3.8 L) Or two 8 oz. (1.9 L) bottles
Shelf Life	One Year

* Typical properties and characteristics are based on samples tested and are not guaranteed for all samples of this product. This data and information is intended as a guide and does not reflect the specification or specification range for any particular property of this product.

LEED Information	
Pre-consumer Recycled Content	0%
Post-consumer Recycled Content	0%
Manufacturing Location	Rockland, MA
Solar Reflectance Index (SRI)	750 g/L

PACKAGING AND STORAGE

Mule-Hide TPO Cut-Edge Sealant is available in 16 oz. bottles packaged 8 per carton. Job site storage temperatures in excess of 90°F (32°C) may affect product shelf life. Should the TPO Cut-Edge Sealant be stored at temperatures below 60°F (15°C), restore to room temperature prior to use. Do not allow to freeze.

KEEP OUT OF REACH OF CHILDREN.

BENEFITS & SUPPLEMENTAL STATEMENTS

- Squeeze bottle packaging allows easy, no mess application
- Available in clear for use on various colors of Mule-Hide TPO
- Provides excellent sealing of exposed reinforcement at cut edges of TPO membrane



Product Data Sheet

MULE-HIDE TPO CUT-EDGE SEALANT

COVERAGE RATES

Approximately 225' to 275' (70 to 80 m) per 16 oz. bottle when applied with 1/8" (3 mm) bead.
Approximately 115' to 140' (35 to 40 m) per 8 oz. bottle when applied with 1/8" (3 mm) bead

INSTALLATION INSTRUCTIONS

1. All surfaces to be sealed with Cut-Edge Sealant must be clean, dry and free from oil, grease, dirt and other foreign materials.
2. Apply a 1/8" (3 mm) bead of Cut-Edge Sealant from the plastic squeeze bottle to seal cut edges of reinforced TPO Membrane. Do not apply Cut-Edge Sealant on vertical surfaces.
3. Sealant should be tack-free in 2 hours and fully cured in 24 hours depending on weather conditions and application thickness.

Review Mule-Hide specifications and details for additional information.

PRECAUTIONS

1. Review the applicable Material Safety Data Sheets for complete safety information.
2. TPO Cut-Edge Sealant is FLAMMABLE – it contains solvents that are dangerous fire and explosion hazards when exposed to heat, flame or spark. Do not smoke while applying. Do not use in a confined area or unventilated area. Vapors are heavier than air and may travel along the ground to a distant ignition source and flashback.
3. Avoid breathing vapors. Keep container closed when not in use. Use with adequate ventilation. If inhaled, remove to fresh air. If not breathing, perform artificial respiration. If breathing is difficult, give oxygen. Call a physician immediately.
4. If swallowed, DO NOT INDUCE VOMITING. Call a physician immediately.
5. Avoid contact with eyes. Safety glasses or goggles are recommended. If splashed in eyes, immediately flush eyes with plenty of water for at least 15 minutes. Contact a physician immediately.
6. Avoid contact with skin. Permeation-resistant gloves (that meet ANSI/ ISEA 105-2005) recommended. Wash thoroughly after handling. In case of contact with skin, thoroughly wash affected area with soap and water.
7. Jobsite storage temperatures in excess of 90°F (32°C) may affect product shelf life. Should the Cut-Edge Sealant be stored at temperatures below 60°F (15°C), restore to room temperature prior to use.
8. KEEP OUT OF THE REACH OF CHILDREN

PROTECTION & SAFETY

Mule-Hide maintains Safety Data Sheets on all of its non-exempt products. Safety Data Sheets contain health and safety information for your development of appropriate product handling procedures to protect your employees and customers. Mule-Hide's Safety Data Sheets should be read and understood by all of your supervisory personnel and employees before using Mule-Hide products in your facilities.

ADDITIONAL INFORMATION

The information given on this PDS is subject to change without notice. Always check the Mule-Hide website at www.mulehide.com for the latest information, changes and updates or contact Mule-Hide Products Company at 800-786-1492.

DISCLAIMER

The statements provided concerning the material shown are intended as a guide for material usage and are believed to be true and accurate at the time of printing. No statement made by anyone may supersede this information, except when done in writing by Mule-Hide Products Co., Inc. Since the manner of use is beyond our control, Mule-Hide does not authorize anyone to make any warranty of merchantability or fitness for any particular purpose or any other warranty, guarantee or representation, expressed or implied, concerning this material. Buyer and user accept the product under these conditions and assume the risk of any failure, any injury person or property (including that of the user), loss or liability resulting from the handling, storage or use of the product whether or not it is handled, stored or used in accordance with the directions or specifications. Mule-Hide must be notified in writing of any claims and be given the opportunity to inspect the alleged failure before repairs are made.



Product Data Sheet

MULE-HIDE MOLDED SEALANT POCKET

PRODUCT DESCRIPTION

Mule-Hide Molded Sealant Pockets are Interlocking, two-piece prefabricated pockets of non-reinforced TPO material used to seal pipe clusters or other irregular shaped penetrations. Pockets length can be adjusted from 7 ½" to 11 ½" by following the pre-molded cutting lines.

BASIC USES

Mule-Hide Molded Sealant Pockets are ideal for sealing irregular, hard to flash penetrations in a Mule-Hide system.



BENEFITS & SUPPLEMENTAL STATEMENTS

- Provides a reliable, cost saving method to waterproof odd shaped penetrations
- Pockets are easily adjustable by cutting on pre-molded cutting lines.
- Larger pockets can be created with the use of pocket extensions

SPECIFICATIONS

PHYSICAL PROPERTIES*	
Color:	White, Gray, Tan
Size:	11.5" to 7.5" length by 6" oval (29 cm to 19 cm by 15 cm)
Packaging:	5 Pockets per carton
Weight:	0.75 lbs each (0.34 kg)

*Typical properties and characteristics are based on samples tested and are not guaranteed for all samples of this product. This data and information is intended as a guide and does not reflect the specification or specification range for any particular property of this product.

INSTALLATION INSTRUCTIONS

1. Place Molded Sealant Pocket around penetration to determine if pocket requires re-sizing. Pocket must maintain a minimum 1" clearance from penetrations. Pocket can be reduced in size by cutting on pre-molded cut lines or enlarged by using pocket extensions.
2. Clean all surfaces of the Molded Sealant Pocket that will be heat welded, along with all inside surfaces that will contact sealer with Weathered Membrane Cleaner.
3. Using Weathered Membrane Cleaner, also clean surface of membrane to which sealant pocket will be welded, along with surface of penetration(s). Use a primer pad with the cleaner if membrane surface has been exposed for an extended period of time.
4. Place Molded Sealant Pocket around penetration(s), overlapping the two sections of the pocket.
5. Place a piece of cardboard (approximately 4" x 4") between the overlapped area of the Sealant Pocket and the field membrane. Cardboard will help prevent Sealant Pocket from becoming welded to membrane when overlaps are first welded.
6. Using a hand welder, weld the angle change in the overlap area. Use of a seam probe may assist in making this weld. Hand welder temperature is typically set between 5 or 6 for this step.
7. Hand weld the remainder of the horizontal overlap.
8. Repeat steps 4 – 6 to weld the overlap on opposite side of the Sealant Pocket.
9. Position Sealant Pocket so that vertical overlap is against the penetration. This will facilitate heat welding of vertical seam by allowing proper pressure to be applied with 2" silicon roller.
10. Weld both vertical overlaps starting at the angle change and working to the top of the pocket.
11. Position Sealant Pocket in final location and hold in place with tack welds on all four side of flange.
12. Weld entire deck flange to the deck membrane.

Product Data Sheet

MULE-HIDE MOLDED SEALANT POCKET

INSTALLATION INSTRUCTIONS (continued)

13. Allow welds to completely cool and then check with seam probe. Make any repairs as needed.
14. Make sure all voids or openings between the penetration(s) and membrane inside the pocket are sealed (use caulk or tape for sealing) before filling pocket. Openings will allow sealer to penetrate into the deck and possibly the building.
15. Apply a thin coat of Tape Primer to interior surfaces and top rim of Sealant Pocket and to the deck membrane enclosed by the pocket. Also apply Tape Primer to the penetration, extending a minimum of 1" above final level of sealer.
16. Complete fill Sealant Pocket with Thermoplastic One-Part Sealer. Ensure that sealer is in contact with top rim of Sealant Pocket.

PRECAUTIONS

1. Maximum temperature of penetration(s) cannot exceed 160°F (71°C).
2. All surfaces coming in contact with sealer must be first cleaned with Weathered Membrane Cleaner, and then primed with Tape Primer.
3. Mule-Hide Thermoplastic One-Part Sealer must completely fill the sealant pocket.
4. There must be a minimum clearance of 1" between sealer pocket and penetration(s).
5. When working on a Mule-Hide TPO roofing system, it is recommended that UV filtering sunglasses be worn.
6. Sealant Pockets or TPO membrane that has been exposed to the weather must be first cleaned with Weathered Membrane Cleaner prior to heat welding. Use a primer pad with the cleaner if surfaces have been exposed for an extended period of time.

STORAGE & HANDLING

Store sealant pockets in a cool, shaded area and cover with light-colored, breathable, waterproof tarpaulins.

PROTECTION & SAFETY

Mule-Hide maintains Safety Data Sheets on all of its non-exempt products. Safety Data Sheets contain health and safety information for your development of appropriate product handling procedures to protect your employees and customers. Mule-Hide's Safety Data Sheets should be read and understood by all of your supervisory personnel and employees before using Mule-Hide products in your facilities.

ADDITIONAL INFORMATION

The information given on this PDS is subject to change without notice. Always check the Mule-Hide website at www.mulehide.com for the latest information, changes and updates or contact Mule-Hide Products Company at 800-786-1492.

DISCLAIMER

The statements provided concerning the material shown are intended as a guide for material usage and are believed to be true and accurate at the time of printing. No statement made by anyone may supersede this information, except when done in writing by Mule-Hide Products Co., Inc. Since the manner of use is beyond our control, Mule-Hide does not authorize anyone to make any warranty of merchantability or fitness for any particular purpose or any other warranty, guarantee or representation, expressed or implied, concerning this material. Buyer and user accept the product under these conditions and assume the risk of any failure, any injury person or property (including that of the user), loss or liability resulting from the handling, storage or use of the product whether or not it is handled, stored or used in accordance with the directions or specifications. Mule-Hide must be notified in writing of any claims and be given the opportunity to inspect the alleged failure before repairs are made.



Product Data Sheet

HELIX[®] MAX LOW-RISE ADHESIVE-DUAL TANK

DESCRIPTION

Rev. 10-2023

Helix[®] Max Low-Rise Adhesive-Dual Tank (“Helix Max Adhesive”) is a low-rise, construction-grade, two-component polyurethane adhesive that is designed to bond Mule-Hide’s insulations and Fleece Back (TPO, PVC or PVC KEE) membranes to a variety of substrates. FM and other agency approvals have been achieved over a variety of deck types and substrates.

PACKAGING

Self-contained tank set (A & B Components) includes guns, spray nozzles, 14” extension nozzle, and hoses in the A-side box.



BENEFITS AND SUPPLEMENTAL STATEMENTS

- HFO Blowing agent
 - Green alternative offering low GWP’s and Zero ODP’s
 - New tips provide improved splatter pattern with more uniform application
 - Improved coverage rates
 - Improved cell structure and product rise
 - Improved string time
- Superior wind uplift resistance / FM approved
- Can be used for most re-roofing projects
- Quick, quiet, low-odor application
- Elongation of up to 150%
- Eliminates the need to pre-drill into concrete and gypsum decks
- Reduces labor by eliminating equipment maintenance and breakdowns
- VOC-free, self-contained system

APPLICATION

General Preparation

1. The surface to which adhesive is applied shall be dry, clean, free of fins, protrusions, sharp edges, loose and foreign materials, oil, and grease. Depressions greater than 1/4” shall be filled with Helix Max Adhesive or other approved patching material. All sharp projections shall be removed. Previously unexposed (shiny) asphalt must be primed with AeroWeb.
2. Seal gaps between the wall/penetration and concrete deck with Mule-Hide F5 Air & Vapor Barrier or other suitable material to avoid condensation issues and positive pressure from air infiltration.
3. Apply Helix Max Adhesive when the substrate and ambient temperatures are 25°F (-4°C) or above. Consult Mule-Hide Technical Department for more details.
4. Fibrous cement decks must be investigated for their ability to retain liquid adhesive, as some types of fibrous cement may allow liquid adhesive to flow through the deck.
5. Static mixing tips for Helix Adhesive (or other manufacturers) and Helix Max Adhesive are not interchangeable, only use the nozzles provided in the packaging for application.

Substrate Compatibility					
Insulation/Underlayments		Roof Decks		Existing Roofing Materials	
Poly ISO 1 & 2	Yes	Concrete	Yes	Smooth BUR	Yes ⁵
StructoDek [®] High Density	Yes	Cellular Lt.Wt. Concrete	Yes ¹²	Gravel BUR	Yes ⁶
Expanded Polystyrene (EPS)	Yes ¹	NVS Lt.Wt. Concrete	Yes ¹²	Mineral Cap Sheet	Yes
Extruded Polystyrene (XPS)	Yes ²	Gypsum	Yes	Granular Modified-Bitumen	Yes
New Sprayed Foam	No ⁹	Cementitious Wood Fiber	Yes	Smooth Modified-Bitumen	Yes
Scarified SPF	No ⁹	Plywood/OSB	Yes	Coal Tar Pitch	Yes ⁷

Helix Max Low-Rise Adhesive-Dual Tank

DensDeck®	Yes	Painted Steel	Yes	Aluminum-Coated BUR	No ⁸
Securock®	Yes	Galvanized Steel	Yes ³	Acrylic-Coated SPF	No ⁹
Oriented Strand Board	Yes	Acoustical Steel	Yes ⁴	Silicone-Coated SPF	No ⁹
Poly ISO 1HD	Yes	Wood Plank	Yes	Aged EPDM, Hypalon, TPO	Yes ¹⁰
				Unexposed (Shiny) Asphalt	Yes ¹¹

- Fleece Back membrane maybe installed directly over minimum 1.5-lb.-density EPS; however, to obtain UL & FM codes, an overlayment of StructoDek® High Density, DensDeck, Securock or Poly ISO insulation is required.
- For insulation attachment only.
- For new galvanized steel decks, power-washing is necessary to remove finishing oil residue if present.
- For acoustical steel decks, fill the flutes with fiberglass or other suitable fill insulation and tack in place with strips of duct tape 3' OC or other adhesive, prior to spraying the deck with Helix Max Adhesive.
- Existing Smooth BUR must be Type III or IV asphalt if the Fleece Back membrane is to be installed directly without insulation.
- A minimum of an approved cover board or insulation is required over properly prepared gravel BUR. **Fleece Back membrane cannot be installed directly over a gravel/slag surface.**
- An insulation providing the necessary R-value must be specified to prevent the coal tar pitch from softening. **Fleece Back membrane cannot be installed directly to coal tar pitch.**
- Aluminum coatings must be removed by power-washing or by physical abrasion prior to the application of Helix Max Adhesive. Adhesion tests are required to confirm sufficient preparation of the substrate.
- SPF roofing assemblies may be considered on a job by job basis. Contact Mule Hide Technical Department prior to bidding.
- Contact Mule-Hide for specific requirements on recover applications over aged EPDM, Hypalon, or TPO membrane.
- Requires AeroWeb for all applications.
- New lightweight concrete must be confirmed by the contractor to be thoroughly dry. Existing substrates will require adhesion tests.

Coverage Rates by Installation Application							
Container Size	Approx. Net Wt./Set	Substrate	Max Coverage Rates* (sq. ft./set)				
			Spray	Splatter**	4" OC	6" OC	12" OC
Dual Tanks (Set)	89 lbs.	Insulation Attachment	N/A	N/A	1100-1,300	1700-1,900	3500-3,700
Dual Tanks (Set)	89 lbs.	Membrane Attachment	N/A	2600-2,800**	1100-1,300	1700-1,900	3500-3,700

*The coverage rates published are estimates and not guaranteed. Application rates are based on ½" wide wet beads applied to a smooth, flat substrate. The adhesive will expand to 2"-3" wide and 1" above substrate. Coverage rates will decrease when used on irregular, rough or porous substrates. For example, installation over a properly prepared gravel surface BUR will consume approximately twice as much adhesive.

**Dual Tanks allow for Splatter application of Fleece Back membranes to smooth surfaces only, the coverage rate is calculated for the minimum required coverage.

Dual Tank Use Instructions

Note: When spraying the dispensing unit for the first time, or when starting a new kit, Mule-Hide recommends that users trigger the gun only a quarter to halfway open until the desired output and spray pattern is achieved. This allows complete control of the flow rate and spray pattern that best fits the application.

- Spray gloves, long sleeves, and protective glasses should be worn during setup and dispensing.
- For best results, use when material is between 70°F and 90°F.
- When applying Helix Max in colder temperatures the use of heating blankets is recommended to ensure the tanks are kept in the proper operating temperature range while dispensing the product.
- Before attaching the nozzle to the dispensing unit, apply a generous amount of petroleum jelly to the face. This will help to prevent contamination by cured foam or chemicals and will help to keep the sealing ports clean. Detailed instructions for attaching the nozzle are included in packaging for A-side tanks.
 - Note:** Nozzles for Helix Adhesive (or other manufacturers) and Helix Max Adhesive **are not** interchangeable, only use the nozzles provided in the packaging for application.
- Connect hoses to tanks prior to opening the A and B tank valves.
- Prior to use, shake both tanks for at least 15-20 seconds, holding the tanks by the handles and using an up and down "pumping" motion. When stopping for more than 2-hours re-shake the tanks.
- When spraying the dispensing unit for the first time, and with each new kit, dispense foam by squeezing the trigger only a quarter to halfway open until the desired output and spray pattern are achieved.
- Clean grease, oil, dirt, and water off surfaces to be foamed.
- When applying Helix Max Adhesive as a bead, the 14" extension nozzle is required and must be attached to the end of the gun nozzle tip before dispensing adhesive. Attach the 14" extension nozzle by rotating the extension tip clockwise onto the end of the gun nozzle tip.**
- When applying Helix Max Adhesive in a splatter application, only the gun nozzle should be used. Do not attach the 14" extension nozzle to the gun nozzle tip. Splatter application can be achieved by triggering the**

Helix Max Low-Rise Adhesive-Dual Tank

gun from a distance of 2'-3' off the deck. Adhesive should be dispersed using a horizontal back and forth motion, achieving 50% coverage of the substrate at 3.75 lbs/sq.

11. Once the trigger is released, it **MUST BE REACTIVATED WITHIN 15 SECONDS** or a new nozzle must be installed. Failure to do this could result in chemical leakage, spills, or splashes which can ruin the dispensing unit and/or hoses.
12. After releasing the trigger, activate the trigger safety to prevent accidental discharge.
 - The dispensing unit face can be kept clean by using petroleum jelly
 - Do not remove the hoses from tanks. Do not flush or clean hoses with air, water, or solvent. Removing and/or cleaning the hoses will compromise the foam.
 - When storing or using adhesive in temperatures below 40°F, the adhesive internal temperature must be returned to 70°F prior to use. Placing adhesive in a heated area (70 - 90°F) for 4 hours should allow liquid adhesive to reach 70 - 90°F.
 - **When temperatures are in excess of 90°F (32°C), utilize white membrane or material to shield the drums from direct sunlight.**

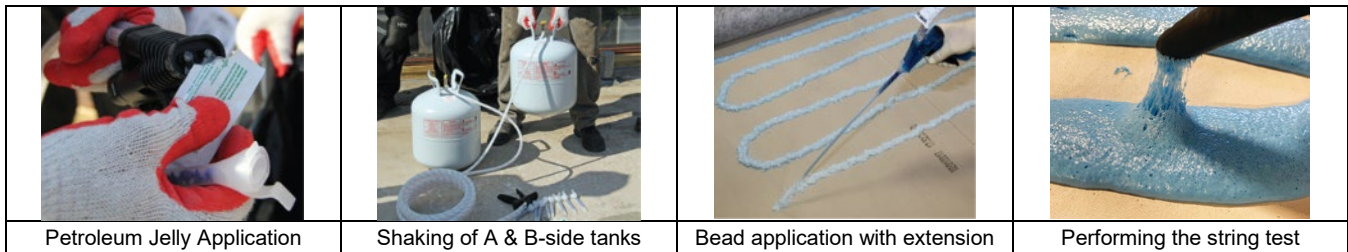

Storage of tanks

1. Close tank valves.
2. Do not store at temperatures above 100°F or below 40°F.
3. The used nozzle should be removed and the dispensing unit should be cleaned with a splice wipe to help keep outlet ports clean and free from any dust, dirt, or chemicals that can affect the proper sealing of the nozzle. **ALWAYS** engage the trigger safety and close all supply valves during storage. Do not purge adhesive from hose.
4. **Do not remove the hoses from tanks. Do not flush or clean hoses with air, water, or solvent. Removing and/or cleaning the hoses will compromise the foam.**

Re-use of Dispensing Unit after Storage

1. Check the face of the dispensing unit to ensure outlet ports are clear and the face of the unit is free from dirt, chemicals, or other debris. If necessary, use a soft cloth or rag to remove any cured foam or chemicals from the face of the dispensing unit. The use of petroleum jelly is recommended to cover the face of the dispensing unit to prevent further contamination or if chemical is accidentally leaked into this area.
2. Attach a new or cleaned nozzle to the dispensing unit.
3. Shake both tanks for at least 15-20 seconds, holding the tanks by the handles and using an up and down "pumping" motion. When stopping for more than 2-hours re-shake the tanks.

Disposal Procedures

1. Eye protection and impervious gloves **MUST** be worn during disposal procedures.
2. **DO NOT dispose of, puncture, or incinerate cylinder tanks while under pressure.**
3. When the job is completed or tanks are empty, pressure must be released from the tanks.
4. With the tank valves open, trigger Dual Tank gun open 100%, discharging remaining adhesive, as well as pressure and propellant, into a lined waste container.
5. After cylinders are empty of all pressure and propellant, tanks must be vented. **CAUTION: tanks could still be under pressure.**
6. Close valves and release remaining pressure from hoses. Remove hoses, and with tank valve positioned **AWAY** from face and others, slowly reopen tank valve and allow excess chemical to drain into a lined waste container and allow pressure to completely vent.
CAUTION: All pressure MUST be vented 100%. Empty tanks could contain potential vapor toxicity hazard. Provide adequate ventilation or respiratory protection (consult SDS).
7. Once cylinder is empty and vented, carefully puncture the friable disc on the top of the cylinder. Cylinders should sit for 30 minutes prior to disposal.
8. **DISPOSE OF EMPTY CYLINDERS AND EXCESS CHEMICAL ACCORDING TO APPLICABLE FEDERAL, STATE, AND LOCAL REGULATIONS.**
9. For recycling information, check with local municipality.

Insulation Attachment

1. Dispense Helix Max Adhesive in beads at the appropriate coverage rate. For steel decks, beads of adhesive must run parallel with, and be on top of, all of the flutes.

Helix Max Low-Rise Adhesive-Dual Tank

- Place insulation boards (maximum 4' x 4' insulation boards when adhesive is dispensed at 12" o.c. or when boards exceed 4" thickness, or 4' x 8' insulation boards when adhesive is applied at 4", or 6" beads) into adhesive after allowing it to rise and develop "string/body". String time will vary based on environmental conditions like temperature and humidity. Do not allow the adhesive to over-cure prior to setting insulation boards. String time will vary based on environmental conditions like temperature and humidity. Do not allow the adhesive to over-cure (lose tack) prior to setting insulation boards.
- Designate one person to walk boards into place and then roll the boards between 5-7 minutes from the initial adhesive application. Boards may be temporarily weighted or relief-cut where necessary to keep the boards in constant contact with the adhesive until the adhesive cures.
- At the beginning of the insulation attachment process and periodically throughout the day, check the adhesion of boards to ensure a tight bond is created and maximum contact is achieved.

Bead Spacing Requirements*				
Building Height	Perimeter Width	Bead Spacing		
		Field	Perimeter	Corner
0-25'	4 Feet	12" OC	6" OC	6" OC
26'-49'	8 Feet	12" OC	6" OC	6" OC
50'-74'	12 Feet	12" OC	6" OC	6" OC
75'-100'	16 Feet	12" OC	6" OC	6" OC
101' or greater	Contact Mule-Hide Technical Department			

*Bead spacing guidelines for 10, or 15-year, 55-mph warranties are listed below. Contact Mule-Hide's Technical Department regarding bead spacing for 20 and 30-year warranties and/or warranties with wind speeds higher than 55 mph.

Fleece Back Installation

Slide-in Method

- Unroll Fleece Back sheet and position. Fold the sheet back in half lengthwise (end-to-end).
- Dispense Helix Max Adhesive to the substrate.
 - For splatter applications, splatter adhesive to obtain a minimum of 50% coverage. Ensure end laps are protected from adhesive.
 - For bead applications, apply at 4", 6", or 12" on center with a min. 1.5" wide foamed bead. Ensure end laps are protected from adhesive.
- Once "string time" occurs, gradually roll Fleece Back membrane into Helix Max Adhesive, checking for "string/body" every few feet. If membrane reaches adhesive that has NOT developed "string/body" stop rolling Fleece Back membrane into adhesive until string develops. As sheet is being installed, immediately start rolling the membrane width-wise with a 150-lb. segmented weighted roller. Repeat process until Fleece Back sheet is fully installed.

Roll-in (Mod Bit) Method

- Unroll the Fleece Back sheet and position in place. Starting at one end of the membrane, using the roll core, carefully roll the membrane back up half way making sure you do not reposition the membrane. Leaving half the membrane laid out will help prevent this.
- Dispense Helix Max Adhesive to the substrate.
 - For splatter applications, splatter adhesive to obtain a minimum of 50% coverage. Ensure end laps are protected from adhesive.
 - For bead applications, apply at 4", 6", or 12" on center with a min. 1.5" wide foamed bead. Ensure end laps are protected from adhesive.
- Once "string time" occurs, gradually roll Fleece Back membrane into Helix Max Adhesive, checking for "string/body" every few feet. If membrane reaches adhesive that has NOT developed "string/body" stop rolling Fleece Back membrane into adhesive until string develops. As sheet is being installed, immediately start rolling the membrane width-wise with a 150-lb. segmented weighted roller. Repeat process until Fleece Back sheet is fully installed.

PRECAUTIONS

- Helix Max Adhesive splatter application is NOT approved for adhering membrane to walls.**
- Review the Safety Data Sheet for complete safety information prior to use.
- High-slope applications may require adhesive to be applied to the bottom of the insulation board to avoid running.
- Review the Safety Data Sheet for complete safety information prior to use.
- The foam produced is an organic material. It must be considered as combustible and may constitute a fire hazard. The foam adhesive must not be left exposed or unprotected. Shield from heat and sparks.
- Do not smoke during application.
- Use with adequate ventilation. Avoid breathing vapors. Wear a NIOSH- or MSHA-approved respirator for organic vapors with prefilters and solvent- resistant cartridges or supplied airline respirators while spraying. Proper safety training is essential for all persons involved in the installation process. If vapor is inhaled, remove to fresh air and

Helix Max Low-Rise Adhesive-Dual Tank

- administer oxygen if breathing is difficult. Consult a physician immediately
- Avoid contact with eyes. Safety glasses or goggles are required. If Helix Max Adhesive is splashed in eyes, immediately flush eyes with plenty of clean water for at least 15 minutes. Contact a physician immediately.
- Avoid contact with skin. Wear long-sleeved shirts and long pants. Wash hands thoroughly after handling. In case of contact with skin, thoroughly wash affected area with soap and water or corn oil. NOTE: Permeation-resistant gloves that meet ANSI/ISEA 105-2005 are required when handling the material or during application.
- Jobsite storage temperatures in excess of 90°F (32°C) may affect product shelf life.
- DO NOT store in temperatures below 40°F.
- If components are stored at temperatures lower than 70°F restore to room temperature prior to use.
- Do not allow Helix Max Adhesive to freeze.
- KEEP OUT OF THE REACH OF CHILDREN.

LEED Information	Dual Tanks
Pre-consumer Recycled Content	0%
Post-consumer Recycled Content	0%
Manufacturing Location	Tomball, TX

Base Component Property*	Part A (1) Polymeric Isocyanate	Part B (2) Polyols, Surfactants & Catalysts
Average Net Weight	9.8 lbs/gal	9.3 lbs/gal
Mixing Ratio by Volume	1:1 Ratio	1:1 Ratio
Packaging	62lbs. (28.1kg)	54lbs. (24.5 kg)
Shelf Life	1 Year	1 Year

* Typical properties and characteristics are based on samples tested and are not guaranteed for all samples of this product. This data and information is intended as a guide and does not reflect the specification or specification range for any particular property of this product.

PROTECTION & SAFETY

Mule-Hide maintains Safety Data Sheets on all of its non-exempt products. Safety Data Sheets contain health and safety information for your development of appropriate product handling procedures to protect your employees and customers. Mule-Hide's Safety Data Sheets should be read and understood by all of your supervisory personnel and employees before using Mule-Hide products in your facilities.

ADDITIONAL INFORMATION

The information given on this PDS is subject to change without notice. Always check the Mule-Hide website at www.mulehide.com for the latest information, changes and updates or contact Mule-Hide at 800-786-1492.

DISCLAIMER

The statements provided concerning the material shown are intended as a guide for material usage and are believed to be true and accurate at the time of printing. No statement made by anyone may supersede this information, except when done in writing by Mule-Hide Products Co., Inc. Since the manner of use is beyond our control, Mule-Hide does not authorize anyone to make any warranty of merchantability or fitness for any particular purpose or any other warranty, guarantee or representation, expressed or implied, concerning this material. This product may be eligible for a Mule-Hide warranty, please check the Mule-Hide website at www.mulehide.com or contact Mule-Hide directly at 800-786-1492 for details. Buyer and user accept the product under these conditions and assume the risk of any failure, any injury person or property (including that of the user), loss or liability resulting from the handling, storage or use of the product whether or not it is handled, stored or used in accordance with the directions or specifications. Mule-Hide must be notified in writing of any claims and be given the opportunity to inspect the alleged failure before repairs are made.



Product Data Sheet

THERMOPLASTIC ONE-PART POURABLE SEALER

PRODUCT DESCRIPTION

Thermoplastic One-Part Pourable Sealer is a one-part, moisture curing, elastomeric polyether sealant providing rapid skin time when exposed to atmospheric moisture forming a waterproof rubber surface in less than an hour. Moisture curing continues for fourteen to twenty-eight days, until a two-inch deep solid rubber seal encases the penetration. Complete cure time will vary depending on relative humidity and temperature. Mule-Hide's Tape Primer must be applied to all surfaces that will be in contact with the Thermoplastic One-Part Pourable Sealer. Primer is not used with the PVC Molded Sealant Pocket. Unused sealant remaining in the pouch will remain useable up to 30 days if pouch is resealed with original cap.



BASIC USES

This product is designed for use with our TPO, PVC & EPDM Sealant Pockets. The sealant's one-part, pourable consistency allows for quick pocket filling without mixing

SPECIFICATIONS

Typical Values*	
Color	White
Odor	Mild ester smell (mint) when wet. Odorless when dry
Specific Gravity	1.37 (11.5 lbs/gallon) to 1.44 (12.0 lbs/gallon)
Viscosity (Brookfield RTV), cps	Self leveling 20,000 – 50,000
Hardness (Shore A) ASTM C 0661	25 to 35
Tack Free Time ASTM C 0679	Less than 1 hour
Low temperature flex PASS	Minus 20°F (Minus 29°C)
Service Temperature ASTM 2453	Minus 40°F to 200°F. (Minus 40°C to 93°C)

*Typical properties and characteristics are based on samples tested and are not guaranteed for all samples of this product. This data and information is intended as a guide and does not reflect the specification or specification range for any particular property of this product.

LEED Information	
Pre-consumer Recycled Content	0%
Post-consumer Recycled Content	0%
Manufacturing Location	Michigan Center, MI
Solar Reflectance Index (SRI)	N/A

PACKAGING

Each carton contains: 4 – 0.5 Gallon pouches per bucket (4-2 liter)
Weight Per Carton: 26 lbs/bucket (11.8 kg)

BENEFITS & SUPPLEMENTAL STATEMENTS

- No mixing required – Ready to use - Resealable pouch using original cap
- Provides a flexible and long-lasting seal around hard to flash projections
- Provides a watertight seal in less than an hour after application

COVERAGE RATES

One 0.5-gallon pouch (2-liter) will fill 122 cubic inches of volume within a sealant pocket. As an example, one 6" TPO, PVC or EPDM Sealant Pocket will require 0.23 gallons (0.87 liters) to fill completely (with no penetrations). Coverage rates are average and may vary due to jobsite conditions.

Product Data Sheet

THERMOPLASTIC ONE-PART POURABLE SEALER

INSTALLATION INSTRUCTIONS

Preparation

1. Surfaces must be free of moisture, dirt and any contaminants. Any previously applied asphalt, caulking or sealants must be removed from the penetration.
2. Fill any voids in the roof deck around the penetration(s) to prevent sealant from seeping through the roof. Pourable sealer must be a minimum of 2" (50 mm) deep. All penetrations must be a minimum of 1" (25 mm) from sides of the pitch pan or sealer pocket.

TPO Application

1. Clean all surfaces with Weathered Membrane Cleaner.
2. Mule-Hide TPO Tape Primer is required for prepping the interior surfaces of the pocket. After welding the pocket in place, apply Mule-Hide TPO Tape Primer to all bonding surfaces, including TPO-c membrane, penetration(s), inside wall and rim of TPO Molded Sealant Pocket. Allow primer to dry.

PVC Application

1. Clean all surfaces with PVC Membrane Cleaner
2. DO NOT PRIME PVC membrane or pocket with Mule-Hide Tape Primer

EPDM Application

1. Clean all surfaces with Weathered Membrane Cleaner
2. Mule-Hide Tape Primer is required for prepping the interior surfaces of the pocket. Apply Mule-Hide Tape Primer to all bonding surfaces, including penetration(s), deck membrane, and uncured flashing that will be in contact with the Thermoplastic One-Part Pourable Sealer. DO NOT apply primer to blue plastic strip that forms inside wall of pourable sealer pocket. Allow primer to dry.

All Applications

1. Remove cap from 0.5-gallon (2-liter) pouch and pour Thermoplastic One-Part Pourable Sealer directly into pocket. Fill pocket completely until rim is covered with Thermoplastic One-Part Pourable Sealer making sure all voids are filled.
2. Avoid breathing vapors. Keep container closed when not in use. Use with adequate ventilation. If inhaled, remove to fresh air. If not breathing, perform artificial respiration. If breathing is difficult, give oxygen. Call a physician immediately.
3. If swallowed, DO NOT INDUCE VOMITING! Call a physician immediately
4. Avoid contact with eyes. Safety glasses or goggles are recommended. If splashed in eyes, immediately flush eyes with water for at least 15 minutes. Contact a physician immediately.
5. Avoid contact with skin. Wash hand thoroughly after handling. In case of contact with skin, thoroughly wash affected area with soap and water.
6. Do not thin. Thinning will affect performance.
7. KEEP OUT OF REACH OF CHILDREN.

Review Mule-Hide specifications and details for additional information.

STORAGE & HANDLING

Shelf life is established at 18 months. Shelf life is based on storage in original, unopened or undamaged containers at temperatures ranging from 60°F to 80°F. Should the Pourable Sealer be exposed to lower temperatures, restore to room temperature prior to use.

Product Data Sheet

THERMOPLASTIC ONE-PART POURABLE SEALER

PROTECTION & SAFETY

Mule-Hide maintains Safety Data Sheets on all of its non-exempt products. Safety Data Sheets contain health and safety information for your development of appropriate product handling procedures to protect your employees and customers. Mule-Hide's Safety Data Sheets should be read and understood by all of your supervisory personnel and employees before using Mule-Hide products in your facilities.

ADDITIONAL INFORMATION

The information given on this PDS is subject to change without notice. Always check the Mule-Hide website at www.mulehide.com for the latest information, changes and updates or contact Mule-Hide Products Company at 800-786-1492.

DISCLAIMER

The statements provided concerning the material shown are intended as a guide for material usage and are believed to be true and accurate at the time of printing. No statement made by anyone may supersede this information, except when done in writing by Mule-Hide Products Co., Inc. Since the manner of use is beyond our control, Mule-Hide does not authorize anyone to make any warranty of merchantability or fitness for any particular purpose or any other warranty, guarantee or representation, expressed or implied, concerning this material. Buyer and user accept the product under these conditions and assume the risk of any failure, any injury person or property (including that of the user), loss or liability resulting from the handling, storage or use of the product whether or not it is handled, stored or used in accordance with the directions or specifications. Mule-Hide must be notified in writing of any claims and be given the opportunity to inspect the alleged failure before repairs are made.



SUMMARY SPECIFICATION

TPO – FULLY ADHERED ROOFING SYSTEM

Revision Date: May 2, 2019

This Summary Specification is a brief overview of Mule-Hide Product's specification and requirements for a Fully Adhered Mule-Hide Reinforced TPO Roofing System and is intended for use as a submittal in a bid package. Specifier's and Mule-Hide Warranty Eligible Applicators must comply with Mule-Hide Product's specifications and requirements prior to design or bid.

Part 1 General

1.01 Description

The Mule-Hide Fully Adhered Reinforced TPO Roofing System utilizes a (maximum) 12' wide, scrim reinforced Mule-Hide TPO membrane in thickness of 45, 60, or 80 mil. Approved insulation is attached to the substrate with either Mule-Hide Insulation fasteners and plates or Mule-Hide Helix® Max low-rise foam adhesives. The TPO membrane is bonded to the insulation with TPO Bonding Adhesive, Low-VOC Bonding Adhesive AeroWeb or Aqua Base 120 water base bonding adhesive. The adjoining sheets are overlapped approximately 3" and seamed together with a min 2" wide heat weld.

1.02 Quality Assurance

- A. The roofing system must be installed by a Mule-Hide Warranty Eligible Applicator in accordance with installation guidelines and detail drawings as approved by Mule-Hide. Prior written approval from the Mule-Hide Warranty Department is required for all deviations from Mule-Hide's published specifications and details.
- B. Projects requesting a Labor and Material Warranty will be inspected by a Mule-Hide Representative to verify that Mule-Hide's installation and material requirements have been met.
- C. Mule-Hide roofing systems offer a variety of Underwriters Laboratories (UL), Factory Mutual (FM) and other ratings. Consult the appropriate approval guides and Mule-Hide Products for specific code approvals.

1.03 Submittals

- A. To ensure compliance with Mule-Hide's warranty requirements contact the Mule-Hide Warranty Department if any of the following conditions exist.
 1. Specified wind speed warranty greater than 55 MPH.
 2. Building height > 100'
 3. Projects located in coastal or high wind zones.
 4. Pressurized buildings
 5. Cold Storage or Freezer Buildings
 6. Membrane exposed to chemicals

- B. Submit a completed Warranty Application form to Mule-Hide prior to bidding. Also include fastener pullout testing results as required for non-standard substrates.
- C. All projects must have a Mule-Hide warranty application number assigned prior to inspection.

1.04 Product Delivery, Storage, and Handling

- A. Deliver materials to the job site in original, unopened containers, with the manufacturer's name, brand name and installation instructions.
- B. Store all materials in a dry, clean area protected from the elements, as per manufacturer's recommendations.

1.05 Job Conditions

- A. All existing wet or damaged roofing materials must be removed and replaced with new materials.
- B. All existing phenolic insulation and sprayed-in-place urethane roofs must be removed.
- C. The specifier must determine the use and placement of vapor retarders. Consult ASHRAE (American Society of Heating, Refrigerating, and Air-Conditioning Engineers, Inc.) and NRCA (National Roofing Contractors Association) publications.
- E. Coordinate work between all trades to avoid traffic over completed sections of roofing.

1.06 Warranty.

Fees are required for all Labor and Material (System) Warranties. System Warranties must be obtained through a Mule-Hide Warranty Eligible Applicator. All projects requesting a System Warranty must be inspected by a Mule-Hide Representative. Components of the roofing system must be supplied by Mule-Hide. Warranty covers only Mule-Hide supplied materials. Sample warranties are available upon request. Contact Mule-Hide Warranty Department for warranty requirements.

Part 2 Products

2.01 General

- A. The components of this roofing system are to be manufactured, supplied, or approved in writing by Mule-Hide Products.

Summary Specification

TPO – Fully Adhered Summary Specification

2.02 Membrane

Mule-Hide White, Gray, or Tan, reinforced 45, 60, or 80-mil thick Thermoplastic Polyolefin (TPO) membrane is used for this system. The membrane is available in a variety of widths up to 12' and in lengths of 100'. Refer to our Product Data Sheet for physical properties and other information.

2.03 Related Materials

Mule-Hide products include: Reinforced and Non-Reinforced Flashings, Bonding Adhesives, TPO Cut-Edge Sealant, TPO Coated Metal, Membrane fasteners and discs, Thermoplastic One-Part Pourable Sealer, All-Purpose Bar, TPO Walkway Roll, Universal Single Ply Sealant, and other components.

Part 3 Execution

3.01 General

- A. Work should begin at the highest point of the roof level and proceed to the lowest point. Work should be completed on a daily bases including flashings, terminations, and daily seals.
- B. Prepare the existing roof deck or substrate according to Mule-Hide design guides and full-system specifications prior to applying the new roofing system.

3.02 Roof Deck Criteria

- A. A proper substrate shall be provided by the building owner. The structure shall be able to withstand normal construction loads and live loads.
- B. Substrate must allow for drainage so that all water is removed within 48 hours after a rain.

3.03 Substrate Preparation

- A. Re-cover projects - All wet or damaged materials must be removed and replaced with new materials.
- B. Substrate must be clean, level, and smooth so that the insulation lays flat. Fresh applications of bitumen based roof cement must be removed or covered.

3.04 Installation

Refer to the applicable Product Data Sheets and Material Safety Data Sheets for cautions and warnings.

A. Insulation Attachment

Attach roof insulation with Manufacturer supplied roofing fasteners and plates or low-rise adhesives. Attachment rates and insulation requirements will vary depending upon substrate and desired wind uplift. Consult Mule-Hide Warranty Department for attachment requirements.

B. Membrane Installation and Hot Air Welding

Place membrane over substrate with minimum 3" overlap at lap seams and positioned so that laps will shed water. Allow membrane to relax. After membrane has relaxed, fold membrane back so that half of the underside is exposed. Apply bonding adhesive as per manufacturer's instructions. Fold back the unbonded half of membrane and repeat bonding procedure. Hot-air weld seams with automatic welder to achieve a min 2" wide heat weld. Hand welding of field seams is not acceptable.

C. Additional Membrane Securement

The membrane must be secured at the perimeter of each individual roof area, projection, and any angle change that exceeds 2" per lineal foot. Consult Mule-Hide's published detail drawings.

D. Membrane Flashing

All existing base flashings are to be removed or covered with a suitable material. Install new membrane flashings as per manufacturer's details and guidelines. Flashings must be terminated along top edge as per appropriate Mule-Hide detail.

E. Other Related Work

1. Walkways should be provided in areas where regular rooftop traffic is expected. Walkways are considered a maintenance item and are excluded from the Mule-Hide warranty.
2. Mule-Hide TPO Walkway Rolls are to be installed over clean, dry surfaces, with a minimum 6" spacing over field seams. Hot air weld the perimeter of the Walkway Roll to the field membrane.
3. Concrete pavers may be used if installed over one layer of HP Protection Mat.
4. Copings, counter flashing and other metal work shall be fastened to resist wind uplift and prevent buckling. Metal should be sealed to prevent moisture infiltration.

This summary specification represents the applicable information available at time of publication. Mule-Hide reserves the right to change this information at any time. Contact Mule-Hide Products or visit our website at www.mulehide.com for the latest updates, changes, or modifications to this summary specification.

MULE-HIDE PRODUCTS CO., INC.
PREMIUM SINGLE-PLY NDL SYSTEM WARRANTY FOR COMMERCIAL BUILDINGS Ver.4.5

Serial Number:

Building Owner:

Building Address:

SAMPLE

Effective Date:

Expiration Date:

In consideration of the warranty fee paid by or on behalf of the above-named Building Owner ("Owner") and the representations to Mule-Hide Products Co., Inc. ("Mule-Hide") by the independent contractor hired by the Owner and registered with Mule-Hide as eligible to apply for warranties ("Eligible Contractor") that the Mule-Hide Roofing System ("System") has been constructed in accordance with Mule-Hide specifications, Mule-Hide warrants to Owner, subject to the following Terms, Conditions and Limitations, that Mule-Hide will be responsible for the repair of leaks in the System installed on the Building for the warranty period indicated above, however, that the System shall have been installed by Eligible Contractor using Mule-Hide products and/or other materials supplied or approved in writing by Mule-Hide. "System" for purposes of this Warranty is defined as the following Mule-Hide brand materials: Single-ply Membrane and Flashing Accessories, Adhesives and Sealants, Insulation, Fasteners, Fastener Plates, Fastening/Termination Bar, Metal Edging/Coping, any other Mule-Hide brand products or other components supplied or approved by Mule-Hide and shall exclude the roof deck, wood nailers, pre-existing roof system to which the new system is applied or covers, support system, and metal flashings (non-Mule-Hide approved or supplied) and any components of the roofing assembly not supplied or approved in writing by Mule-Hide. The watertight integrity of walls, parapet walls and other adjacent structures is not covered. The paint finish on any Mule-Hide labeled metal product that is part of the System is not covered by this Warranty. Metal finish warranties can be obtained by contacting Mule-Hide directly. There is no dollar limitation (NDL) on covered repairs. Any dispute, controversy or claim between Owner and Mule-Hide arising out of or related to this Warranty or the Building shall be settled by final and binding arbitration in accordance with the rules of the American Arbitration Association for the Construction Industry. By accepting this Warranty, Owner represents that the Building is a commercial structure and is not used for owner's personal or household purposes. In consideration of the protection afforded by this Warranty, Owner accepts the following Terms, Conditions and Limitations:

1. Within thirty (30) days after Owner or any of its agents discovers (or a reasonable person in Owner's or agent's position would have discovered) any leak, Owner must give written notice (the "Notice") to Mule-Hide Warranty Claims (notice to the contractor, a re-seller or an authorized Mule-Hide Sales Representative is not notice to Mule-Hide Warranty Claims) of the existence of each leak in the System or Mule-Hide will have no responsibility for the repairs.
2. Mule-Hide shall have the right to inspect the System after receiving the Notice to determine the cause(s) of the leak before incurring any obligation hereunder. In the event the cause of the leak is not covered by the Warranty, Owner will pay to Mule-Hide a reinspection fee and expenses (in accordance with Mule-Hide's standard charges) promptly after Mule-Hide issues an invoice for same. If, upon Mule-Hide's inspection, Mule-Hide determines that the leaks in the system are caused by defects in Mule-Hide's materials or workmanship of the Contractor, Owner's remedies and Mule-Hide's liability shall be limited to Mule-Hide's repair of the portion of the System determined to be leaking using methods determined to be suitable at Mule-Hide's discretion. In no event shall Mule-Hide be obligated to perform additional services (e.g. roof drains, equipment relocation, old roof removal, etc.) or provide materials or services beyond the scope of the Owner's original contract with Contractor.
3. This warranty may be transferred provided the original owner follows the Mule-Hide Warranty Transfer Procedure. Contact Mule-Hide Technical Department at 1-800-786-1492 for a copy of the procedure.
4. If the System is damaged by any of the following causes, this Warranty shall not apply to such damages:
 - (a) Any natural cause, including but not limited to lightning, the infestation or presence of plant, mold, fungi, bacteria, insects or an animal, or earthquake, peak gust wind speeds in excess of 55 mph, hurricane, tornado, hail greater than 0 inches in diameter (as reported by the National Climatic Data Center), or any debris resulting from any of these causes. Mule-Hide shall not be responsible for any changes in appearance or surface imperfections caused by hail events.
 - (b) Acts of negligence, accident, misuse or abuse, including but not limited to vandalism, fire, falling object, civil disobedience, or acts of war.
 - (c) The use in the System of metal work, coping, counter-flashing, rain-carrying components or other material not furnished or otherwise approved in writing by Mule-Hide.
 - (d) Environmental fallout, chemical attack, use of products or materials incompatible with the System or the presence within or outside the Building of any commercial or industrial solvent, acid, caustic fluid, petroleum product, wax, grease, absorbent, clay or plasticizer.
 - (e) Negligence of a contractor who is not the Eligible Contractor, or failure of the material or the workmanship provided by such a contractor.
 - (f) Interior condensation and any resulting damage or condition, including but not limited to, mold, fungi or bacteria.
 - (g) The infiltration of moisture in, through or around the building through any mechanism other than through the System, including but not limited to, any structural defect, wall, or other Building structure, or anything that penetrates the System, including but not limited to any vent, coping or rooftop equipment and any resulting damage or condition, including but not limited to, mold, fungi or bacteria.
 - (h) Any deterioration, failure, settlement or movement of building components, including but not limited to the roof structure, roof substrate (pre-existing roof system or retained components), roof deck, wood nailers, walls, mortar, HVAC units, skylights, etc. or the expansion or contraction of any counterflashing or metal work.
 - (i) Defects in the building, pre-existing conditions or roof design, including but not limited to any conditions that prevent positive drainage.
5. Mule-Hide may, in its discretion, suspend or cancel this warranty if the roof is damaged by any cause listed above as an exclusion from coverage that may affect the integrity of the roof tightness of the roof.
6. Occurrence of any of the following shall render the Warranty cancelable in Mule-Hide's sole discretion and terminate obligations under this Warranty:
 - (a) Alteration or repair made on or through the roof without prior written authorization from Mule-Hide.
 - (b) Placement upon or attachment to the roof of any object (including but not limited to any structure, fixture or utility) without prior written authorization from Mule-Hide.
 - (c) Owner's or the Building occupant's failure to use reasonable care in maintaining the roof including, but not limited to, items listed on the reverse side of this document titled "Mule-Hide Owner's Care and Maintenance Information".
 - (d) Internal positive pressure condition which causes or contributes to a partial or total failure of the roof.
 - (e) Owner's sale of the Building or purported assignment of this Warranty, except as provided in (3), above.
 - (f) Owner's failure to comply with every Term, Condition and Limitation in this Warranty.
7. Mule-Hide, its agents, employees and contractors shall have unrestricted access to the roof during regular business hours. By accepting this Warranty, Owner agrees to arrange for removal of water, snow, ice, equipment, any paving or overburden at Owner's expense to allow for investigation or repairs to be made. The Owner is responsible to provide safe access to the roof.
8. All bills for installation, supplies and services shall have been paid in full to Eligible Contractor and all material suppliers before Mule-Hide incurs any obligation or liability under this Warranty. It is the Owner's sole responsibility to confirm that payment has been made to Eligible Contractor and all material suppliers.
9. The failure of Mule-Hide at any time to assert or enforce any Term, Condition and Limitation shall not be construed to be a waiver thereof, or of any other Term, Condition or Limitation. Unless otherwise agreed in advance and in writing, any inspections made by Mule-Hide are limited to a surface inspection only. All inspections are for Mule-Hide's sole benefit, and do not constitute a waiver of any terms and conditions herein.
10. Any and all other express warranties are superseded hereby and this Warranty is in lieu thereof.
11. Owner acknowledges that the Eligible Contractor is not an agent or other legal representative of Mule-Hide. Mule-Hide is not liable for any promise, representation or other responsibility of Eligible Contractor or any other party. This warranty is not binding upon Mule-Hide unless executed by an executive officer of Mule-Hide or a duly authorized employee of Mule-Hide's Warranty Department. No representative or employee of Mule-Hide, or any other party, may alter this Warranty without the prior written consent of an executive officer of Mule-Hide. This Warranty constitutes the entire understanding of the parties with respect to the subject matter contained herein, and revokes and supersedes all prior agreements, whether written or oral, between the parties. This Warranty shall take precedence over any other documents or representations (whether oral or written, and by whomever made) which may conflict with this Warranty.
12. The predominant factor in the construction and performance of the System is the design and construction services of the contractor and not the sale of goods. In addition, Owner acknowledges that Owner had a duty hereunder to exercise reasonable care in the selection of a contractor.
13. Mule-Hide is not liable for the cleanliness or discoloration of the System caused by environmental conditions including but not limited to dirt, pollutants or any biological agent.

MULE-HIDE DOES NOT WARRANT PRODUCTS UTILIZED IN THIS INSTALLATION WHICH IT HAS NOT FURNISHED; AND SPECIFICALLY DISCLAIMS LIABILITY, UNDER ANY THEORY OF LAW, ARISING OUT OF THE INSTALLATION AND PERFORMANCE OF, OR, DAMAGES SUSTAINED BY OR CAUSED BY, PRODUCTS NOT FURNISHED BY MULE-HIDE.

Building Owner's Roof Care and Maintenance Guidelines ver.2.03

Following are guidelines on how to care for your roofing system to help ensure a long useful service life. The manufacturer's warranty is not a maintenance program or agreement. There are various items associated with your roof system that are not covered under the warranty. It is the responsibility of the Building Owner to regularly inspect and maintain their roofing system.

Mule-Hide strongly recommends the Building Owner institutes an annual inspection program with written documentation of any activities on the roof. Maintain a log of maintenance procedures and people accessing the roof. This aids the Building Owner in determining the source of any damage to the roof. The roofing system should be inspected at least twice a year (once in the spring and once in the fall) and after every major storm. These inspections should be performed by a Mule-Hide Warranty Eligible Contractor or someone specially trained in roofing systems.

READ YOUR WARRANTY CAREFULLY BEFORE EXCUTING ANY ROOF-TOP WORK OR FILING OF A CLAIM.

Understand the terms and conditions to avoid adversely affecting the warranty.

General Guidelines

1. Keep the roof surface clean of debris, especially at drain areas to avoid clogging. Good roofing practice suggests that water not be allowed to remain on the roof for more than 48 hours after a rain. Keeping the roof clear of debris will allow for proper water run-off and avoid overloading the roof with standing water.
2. Keep chemical and petroleum products (acid, chemicals, solvents, greases, oils or any liquids containing petroleum products) off the membrane to avoid degradation. If swelling occurs, contact Mule-Hide immediately.
3. Do not exhaust kitchen wastes (such as but not limited to vegetable oils or animal fats) directly onto the roof surface.
4. TPO and PVC membranes may be used for restaurant roofs but must have a rooftop maintenance program in-place to ensure that accumulations of animal fats/grease are regularly removed and the membrane surface is cleaned periodically.
5. Walkways must be provided if regular rooftop traffic is required, such as routine servicing of rooftop equipment. Exercise caution when not walking on walkways, especially on white roofing surfaces as ice or frost build-up may not be visible. All membranes and coatings are slippery when wet.
6. When it is necessary for workers to be on the roof to service rooftop equipment, workers should be cautioned to use walkways (when provided) and to exercise care with their tools and equipment to avoid causing damage to the roof system that may result in leaks. It is recommended that the Building Owner or property manager keep a "Roof-top Maintenance and activity Log" to track dates and activities by personnel or other trades.
7. Handprints, footprints, general traffic grime, industrial pollutants and environmental dirt and debris may be cleaned from the roof surface by scrubbing with detergent and water, followed by rinsing with clean water. To maximize and maintain reflectivity, it is suggested that white surfaces be cleaned once every two years.
8. Keep roof maintenance items, such as counterflashings, metal curbs, metal ductwork, etc., sealed watertight at all times. All exposed mastic and sealants regardless of the purpose or function, are required maintenance items to be remediated by the Building Owner, including but not limited to pitch pans and metal flashing sealants.
9. Loss of granules from mineral surfaced membranes is typical and not a manufacturing defect. In cases of granule loss that becomes more noticeable, additional surfacing may be applied as directed by Mule-Hide.
10. Protective coating systems may oxidize and weather, losing overall dry film thickness. This is normal and not a defect in the material.
11. When performing inspections, examine all areas adjacent to the roof, parapet walls and adjoin structures. Damage to items such as masonry, failing mortar joints, loose or missing sealants, loose stone or tiles, loose or improperly sealed counterflashings, etc., may be the source of leaks that are inadvertently blamed on the roofing system. These items need to be addressed by properly trained personnel to avoid damage to the roof system.
12. If any changes are to be made to the roof system such as but not limited to equipment changes, additions or removal, modifications to the roof systems, etc., contact Mule-Hide for prior approval. Work directly related to the roof system must be completed by a Mule-Hide Warranty Eligible Contractor.
13. If you have a leak, check for the obvious such as clogged drains, broken skylights, loose counterflashings, broken pipes, leaking HVAC units or damage caused by service personnel or storms. Note: When leaking occurs, items such as heavy or light rain, wind direction and speeds, temperature and time of day are all important clues for tracking suspected leaks. Does the leak start and stop with the rain, or, does leaking continue after rain has ceased?

If you believe that the leak may be covered under a Mule-Hide warranty, please notify Mule-Hide Warranty Claims with written notice in accordance with the warranty terms. For temporary repairs, only use products that are compatible with the roof system installed. Do not use any asphalt products on any single-ply roof system as use of such product may cause additional damage to the roof system. Please refer to the Mule-Hide Website (www.mulehide.com) for compatible products that may be used for temporary repairs on your roof system. Non-compatible products used that cause damage to the roof system will have to have that area removed and replaced at the Building Owner's expense. Compliance with the above items will aid in assuring a durable, watertight roof system.

Mule-Hide Product Co., Inc.
P.O. Box 1057
Beloit, WI 53512-1057
Phone: 800-786-1492